

ORIGINAL



14

EVOLUTION IS A JOURNEY

Kilometers travelled teach us change and improvement, to look at things from a new perspective.

32

HOW MANY ROADS

Sometimes a seemingly simple object hides a fascinating, beautiful story.

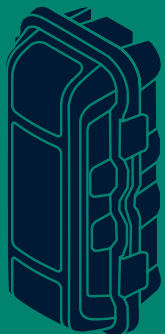

54

LIMITLESS: A STORY OF SELF-ESTEEM

Just when we don't expect to find it, that is where imagination is at its best.

ORIGINALLY YOURS | 

Original is...

Original

It's a word that says so much.
About us and you.

It opens a universe of meanings. It goes straight to the core, to the origin.
Original. Like a fingerprint, like a signature.



Original. Like a new way to create improvement.

Original. Like the drive for efficiency, even in the simplest things.

Original. Like something akin to us, representing our uniqueness and diversity.

Original. Like beauty, the positive feeling that makes life better.

In details too.

Original. To us, it's more than a word.
It's the way we have chosen to do our part,
at our best, in a system where we are
all connected.
It's an attitude.
It's our commitment.
It's the promise to keep going
in our journey
with you.

COMPANY

OVER 70 YEARS OF PASSIONATE COMMITMENT
TO PROVIDING ORIGINAL,
VALUE DRIVEN SOLUTIONS FOR INDUSTRIAL
AND COMMERCIAL VEHICLES.



LAGO is a family-owned company that operates in the industrial vehicle accessories and components sector, where it has built a recognizable and respected identity.

Established in Italy, at its historical headquarters in Fontaniva, Padua, the company boasts over 70 years of experience and a history of constant growth, all while staying true to the roots and the values from which it was born.

Over time, the name LAGO has become synonymous with high quality, reliability, and creativity. We create tool and storage boxes, mudguards, fire extinguisher boxes, water tanks and other complementary

products for industrial and commercial vehicles. We design them to significantly improve the customer experience, providing "Made in Italy" solutions that aim to reduce assembly time and the number of vehicle parts. Our goal is to enhance overall efficiency for those who use our products daily. How is that possible? By balancing two crucial aspects: meticulous attention to detail and a broader view of the product within its overall context.

However, we understand that a company's distinction lies not only in the quality of its products and services. We firmly believe that fair competition can be a healthy incentive for

innovation and that trust is developed day by day through respect for people and rules. This is why our Code of Ethics is particularly valuable to us, as it encapsulates our commitment to work and serves as a constant source of inspiration for our company.

LAGO products are available in more than 50 countries through a network of long-standing collaborations with highly qualified distributors and partners. Transparency and fairness towards partners and market players guide us in every choice and action. We work with great passion for improvement, focusing on what can truly make a difference.

The journey continues, always looking towards the future in search of more complete, practical, and efficient solutions.

In one word:
ORIGINAL.

WE ARE A GROUP

LAGO'S PROJECTION TOWARDS NEW MARKETS
HAS BEEN STRATEGICALLY SUPPORTED
BY THE ESTABLISHMENT OF COMPLEMENTARY
BUSINESS ENTITIES:
AAISTER, LAGOGENESIS AND LAGO DO BRASIL.



LAGO ACCESSORI

The mother company of our Group. For over 70 years, LAGO ACCESSORI has been translating its commitment and passion into the creation of original and valuable solutions for industrial and commercial vehicles: the result is products that stand out in the market for their design, engineering and high performance. The range includes toolboxes, fire extinguisher boxes, mudguards, as well as water tanks, special carriers, protection devices and first aid hygiene kits.

AAISTER

AAISTER, distribution specialist in Italy for the industrial vehicle sector, handles the entire LAGO range exclusively, in conjunction with other premium branded complementary products. Since 2009 AAISTER has been working closely with the most respected representatives of Italian vehicle construction, body shops and top notch retailers through its highly organized sales network. With a mission to be a supply partner that can be counted on, AAISTER's focus lies in putting a complex and highly fragmented supply within reach thanks to a strategically positioned network of experienced, loyal and highly competent operators.

LAGOGENESIS

LagoGENESIS is the technological heart of the group: a state-of-the-art laboratory where mechanical and electronic devices for the protection, management and control of fuel inside the tank of industrial and commercial vehicles are designed and developed. All LagoGENESIS solutions are inspired by the principles of simplicity, safety and high reliability.

LAGO DO BRASIL

LAGO do Brasil is a production and trading company active in one of the most industrialised areas of southern Brazil. It produces accessories and components for the industrial vehicle sector designed specifically for the needs of the local market, which lie on the crossroad between LAGO do Brasil's research and development capabilities and the established know-how of LAGO, the Italian parent company, which brings its legacy for quality Italian made products.

INDEX

Imagination is part
of our journey together.

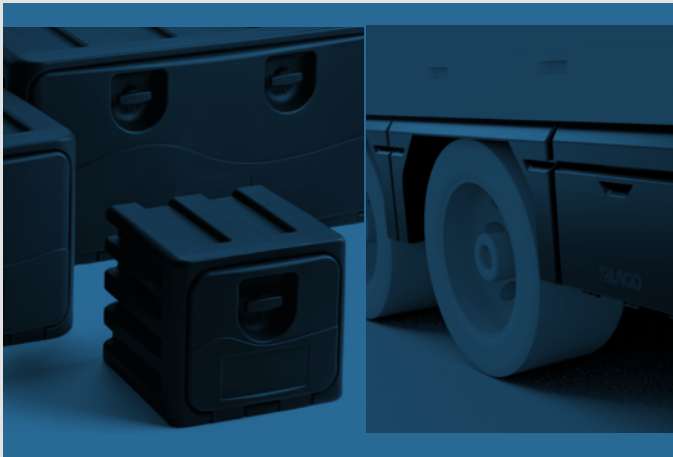

14

> JOURNEYLOGUE

EVOLUTION IS A JOURNEY

Kilometers travelled teach us
change and improvement,
to look at things from a new
perspective.

32

> JOURNEYLOGUE

HOW MANY ROADS

Sometimes a seemingly simple
object hides a fascinating,
beautiful story.



54

> JOURNEYLOGUE

LIMITLESS: A STORY OF SELF-ESTEEM

Just when we don't expect to find
it, that is where imagination is at
its best.

TOOL & STORAGE BOXES



12 > 25

BLACK DOG
VERTIGO
KOMPOS-IT
MOTHER TRUCKER
ORIGIN
DAY TRIPPIN'
TOOL BOXES ACCESSORIES

WATER TANKS



26 > 29

TANKY
TANKYTOO

MUDGUARDS



30 > 51

KOMPLEET KOMBI
KOMPLEET KOMBI TIPPER
PORTTER KOMBI
KOMPLEET
KOMPLEET KOMMA
WHEELMATE
WHEELMATE PRO
WHEELMATE PRO KOMPLEET

SPRAY BUSTER
QWIKLOK
BRACKETS AND FASTENING OPTIONS
TOOBEE
ROCK'N'ROAD
INTERFLEX

SAFETY & HYGIENE

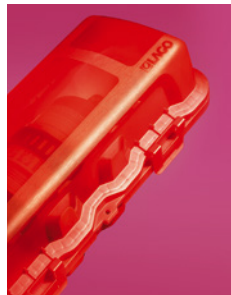

52 > 63

SHELLY
SHELLY SOLID RED
FITEASY
RELEASEY

FOLPY
SLYKÖN
GRABBY

SPECIAL CARRIERS



64 > 69

HOLDYX - ROLLYX
FORMEEGA
PORTTER UNIVERSAL
HOSE PROTEX

PROTECTION DEVICES



70 > 81

SOPÉO
MINI SOPÉO 13-14
LAGOMAX
SEENA 2.0
SIDE BASIC SET

12



LAGO

EVOLUTION
IS A JOURNEY > 14

BLACK DOG
VERTIGO
KOMPOS-IT
MOTHER TRUCKER
ORIGIN
DAY TRIPPIN'

TOOL & STORAGE BOXES



EVOLUTION IS A JOURNEY.

«BECAUSE THOSE WHO USE THEIR IMAGINATION ALSO KNOW HOW TO REALLY TRAVEL. AND THOSE WHO KNOW HOW TO TRAVEL NEVER STOP USING THEIR IMAGINATION.»

Have you ever thought about what evolution is? I have...
In nature, some changes are made to last. They become 'successful' because they improve upon what came before. That's how it was for me. I was different. I was highly evolved, in fact. I was the first of my kind.

No one had ever thought that a toolbox could be two-colored, and beautiful to look at. Or that it could be equipped with an external instead of internal locking system.

But let's be clear: innovations like mine don't happen by chance, like a roulette game. They are the result of trials, many trials. Of tests and errors. Of tenacity and imagination. Of taking new paths, at

one's own risk. Of the work of determined and imaginative people. Of someone who knows what it takes when you're on the road... I was designed for that purpose and wanted to be that way. There is nothing random about me. Not even the smallest detail. I made myself known and recognized, even with an unusual name to remember: Vertigo.

Take, for example, the material I am made of, which might be taken for granted but shouldn't be: resin. It is strong yet light at the same time, and for travellers, that means a lot. It is versatile; it can take any shape you give it. It can also be molded using different technologies: in my case with rotational molding, a system that

allows very large parts to be created. An extraordinarily resistant material. So strong that I can easily replace a metal box in terms of strength and durability.

But that's not all. In the place where I was born, injection molding is also used, allowing for any shape to be created, for any need. I'm talking about solutions in every format and size, for vehicles from the lightest to the heaviest. Toolboxes with a precise surface finish, recognizable even to the touch. Toolboxes that are part of a coordinated, aesthetically coherent product array, where ergonomics and user-friendliness are key features.

After me, the evolution continued, and my sisters arrived.

Each one born from a journey. Designed for the traveller. Each ready for many more journeys to come. Black Dog, Daytrippin', Kompos-it, Mother Trucker, Origin. Like any true traveller, able to adapt to any context, always bringing out the best. Because those who use their imagination also know how to really travel. And those who know how to travel never stop using their imagination.



**HAVE YOU EVER
THOUGHT ABOUT WHAT
EVOLUTION IS?**



BLACK DOG

TOOL & STORAGE BOXES



UV stabilized polyethylene

Colour: black and red (UV stabilized)

Form and function - Impact and shock resistance without compromise

11 different sizes

Water and dust resistant gasket seal

Heavy duty polypropylene multi-wall base panel

Conventional opening with 2 handles (1 handle for sizes 400 and 500) - Keys, spare keys and keyhole caps included

Can be used as side protection device according to regulation ECE 73R01
further details under download section www.lagoaccessori.it

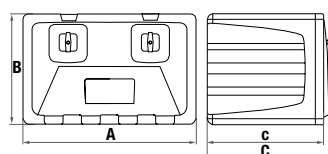

Code	A	B	c-C	kg	capacity (liters)	max load (kg)*	std packaging
44 50 55 115	400	350	400-420	5,7	40	30	30 pcs
44 50 55 103	500	350	400-420	6,2	46	35	32 pcs
44 50 55 083	600	450	470-490	9,2	90	50	24 pcs
44 50 55 081	600	450	650-670	10,5	140	60	16 pcs
44 50 55 084	600	550	650-670	11,5	164	65	16 pcs
44 50 55 060	700	450	470-490	10,5	108	55	18 pcs
44 50 55 053	700	450	650-670	12	140	65	12 pcs
44 50 55 040	750	360	330-350	7,8	55	40	27 pcs
44 50 55 033	800	450	470-490	11,5	123	60	18 pcs
44 50 55 020	1000	500	470-490	15	180	70	12 pcs
44 50 55 017	1000	500	650-670	18	260	75	8 pcs

*Indicated value is the maximum suggested distributed load using the dedicated LAGO support brackets



BLACK DOG CUSTOMISATION

Plastic laminated reflective adhesive label

Four colour process print

Label dimension: 190x80mm

all dimensions are in mm

VERTIGO

TOOL & STORAGE BOXES



UV stabilized polyethylene

Colour: black and grey (UV stabilized)

Form and function - Impact and shock resistance without compromise

11 different sizes

Water and dust resistant gasket seal

Heavy duty polypropylene multi-wall base panel

Exclusive double release lever locking system with "M.L.D." magnetic device (1 locking lever for sizes 400 and 500) keys

Spare keys and keyhole caps included

Can be used as side protection device according to regulation ECE 73R01
further details under download section www.lagoaccessori.it

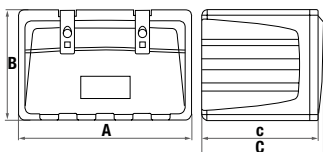

Code	A	B	c-C	kg	capacity (liters)	max load (kg)*	std packaging
44 50 25 115	400	350	400-420	5,7	40	30	30 pcs
44 50 25 103	500	350	400-420	6,2	46	35	32 pcs
44 50 25 083	600	450	470-490	9,2	90	50	24 pcs
44 50 25 081	600	450	650-670	10,5	140	60	16 pcs
44 50 25 084	600	550	650-670	11,5	164	65	16 pcs
44 50 25 060	700	450	470-490	10,5	108	55	18 pcs
44 50 25 053	700	450	650-670	12	140	65	12 pcs
44 50 25 040	750	360	330-350	7,8	55	40	27 pcs
44 50 25 033	800	450	470-490	11,5	123	60	18 pcs
44 50 25 020	1000	500	470-490	15	180	70	12 pcs
44 50 25 017	1000	500	650-670	18	260	75	8 pcs

*Indicated value is the maximum suggested distributed load using the dedicated LAGO support brackets



VERTIGO CUSTOMISATION

Plastic laminated reflective adhesive label

Four colour process print

Label dimension: 190x80mm

all dimensions are in mm

KOMPOS-IT

INTEGRATED SYSTEM OF MULTI-PURPOSE MODULAR STORAGE BOXES



Copolymer Polypropylene Compounded

Colour: black (UV stabilized)

HIGH STORAGE VOLUME

VERSATILE: a vast choice of options yields configurations which are suited to transportation of ADR and load security equipment, tools and more.

COMFORT: thanks to the dedicated isothermal module, it's possible to set up a traveling kitchen.

Six basic elements to be easily and quickly assembled by means of simple interlocking snaps

60% volume reduction (transport and stock)

Each single module is specifically designed for its function in the assembly:

- the bottom module is well structured for loading
- the lateral parts are well structured to bear the brackets

Fully integrated lid

Manual opening equipped of key lock and lock cover

Kompos-it is lab and road tested with 60 kg distributed load using dedicated mounting hardware produced on specification by LAGO. Use of such dedicated mounting hardware is compulsory to ensure optimum product performance.

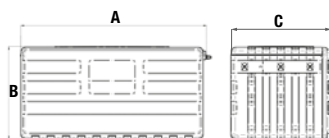

Code	description	A	B	C	kg	max load (kg)*	std packaging
80 60 62 115.0100	KIT KOMPOS-IT manual opening doorstop chain set installed	1200	600	650	25	60	12 pcs
80 60 62 095.0100	KIT KOMPOS-IT manual opening doorstop chain set installed	1000	600	650	20	50	12 pcs

*Indicated value is the maximum suggested distributed load using the dedicated LAGO support brackets



AVAILABLE OPTIONS

Isothermal unit: strong isothermal unit equipped with its own lid can be opened independently to optimize efficiency. Provided in kit form to reduce volume during transport. Can be used as stand alone unit designed for use with standard ice packs.

- Platform and chassis mounting bracket kit
- Vertical and horizontal dividers
- Worktop applicable on the inner side of the door
- Drawers
- Led lighting

all dimensions are in mm

SUPPORT BRACKET KITS



Code	description	kg	std packaging
31 16 67 004	Platform mounting bracket kit	8	1 pair



31 16 66 004	Chassis mounting bracket kit	10	1 pair
--------------	------------------------------	----	--------



SPARE PARTS AND ACCESSORIES



Code	description	kg	std packaging
07 09 16 001	Isothermal box 400 x 600 x 650 mm (dis-assembled) FOR ISOTHERMAL UNIT INSTALLATION VERTICAL DIVIDER IS NECESSARY	0,3	1 pc



81 60 40 044	Vertical divider 600 x 650 mm	1,1	12 pcs
--------------	-------------------------------	-----	--------

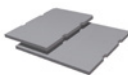

81 60 41 021	Horizontal divider 400 x 650 mm	0,5	12 pcs
--------------	---------------------------------	-----	--------

81 60 41 007	Horizontal divider 200 x 650 mm	0,3	24 pcs
--------------	---------------------------------	-----	--------



81 30 45 072	Aluminium worktop 1200 x 600 mm	1,8	bulk
--------------	---------------------------------	-----	------



81 30 45 063	Aluminium worktop 1000 x 600 mm	1,6	bulk
--------------	---------------------------------	-----	------



81 60 56 006	Drawer (equipped with standard guides) FOR DRAWER INSTALLATION HORIZONTAL DIVIDER IS NECESSARY	1	12 pcs
--------------	---	---	--------



05 09 16 027	Led light	0,1	bulk
--------------	-----------	-----	------



07 10 16 001	Doorstop chain set	0,2	bulk
--------------	--------------------	-----	------



07 05 16 002	Locking kit	0,05	bulk
--------------	-------------	------	------

all dimensions are in mm

MOTHER TRUCKER

TOOL BOXES



UV stabilized polypropylene copolymer

Colour: black (UV stabilized)

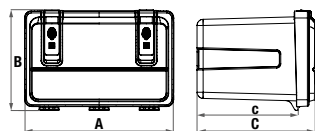
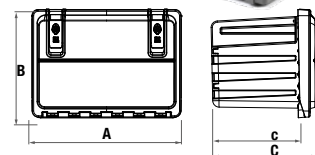

Scratch resistant proprietary surface

Enveloping door with lever locking system: double release system with MLD magnetic device - more security and reliability

Reinforcement ribs for impact and shock resistance

Transport and logistics optimization: can be delivered fully assembled or as separate nested parts, assembly of parts is easy and no tools are required

Can be used as side protection device according to regulation ECE 73R01
further details under download section www.lagoaccessori.it

Fully assembled

Code	A	B	c-C	figure	kg	capacity (liters)	max load (kg)*	std packaging
44 60 62 116	400	350	300-375	B	3,3	30	30	40 pcs
44 60 62 100	500	350	380-455	B	3,8	46	35	40 pcs
44 60 62 090	600	400	400-475	B	5,7	70	45	30 pcs
44 60 62 045	690	500	400-480	A	6,8	98	50	20 pcs
44 60 62 043	750	350	225-300	A	4,4	40	40	28 pcs
44 60 62 042	750	350	375-450	A	5,2	65	40	20 pcs
44 60 62 030	800	500	400-475	B	8,2	126	55	18 pcs
44 60 62 020	1000	500	400-480	A	9,7	148	70	15 pcs

Nested bodies and separate lids

44 60 63 116	400	350	300-375	B	3,3	30	30	50 pcs
44 60 63 100	500	350	380-455	B	3,8	46	35	64 pcs
44 60 63 090	600	400	400-475	B	5,7	70	45	36 pcs
44 60 63 045	690	500	400-480	A	6,8	98	50	30 pcs
44 60 63 043	750	350	225-300	A	4,4	40	40	30 pcs
44 60 63 042	750	350	375-450	A	5,2	65	40	30 pcs
44 60 63 030	800	500	400-475	B	8,2	126	55	28 pcs
44 60 63 020	1000	500	400-480	A	9,7	148	70	24 pcs

*Indicated value is the maximum suggested distributed load using the dedicated LAGO support brackets

MOTHER TRUCKER CUSTOMISATION

Silk screen printing, one or more colours, according to quantities

Laser printing, one colour

Logo maximum dimension according to toolbox/printing size

all dimensions are in mm

ORIGIN

TOOL BOXES



UV stabilized polypropylene copolymer

Colour: black (UV stabilized)

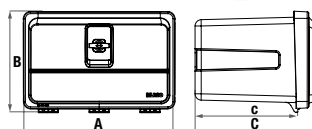
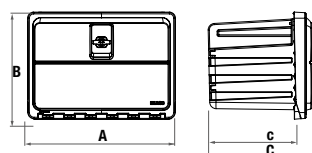

Scratch resistant proprietary surface

Equipped with multipoint locking system for increased security - 1 or 2 handles - Key, spare key and keyhole cap included

Water and dust resistant gasket seal

Reinforcement ribs for impact and shock resistance

Transport and logistics optimization: can be delivered fully assembled or as separate nested parts, assembly of parts is easy and no tools are required

Can be used as side protection device according to regulation ECE 73R01
further details under download section www.lagoaccessori.it

Fully assembled

Code	A	B	c-C	figure	kg	capacity (liters)	max load (kg)*	std packaging
44 60 64 116	400	350	300-375	B	3,3	30	30	40 pcs
44 60 64 100	500	350	380-455	B	3,8	46	35	40 pcs
44 60 64 090	600	400	400-475	B	5,7	70	45	30 pcs
44 60 64 045	690	500	400-480	A	6,8	98	50	20 pcs
44 60 64 043	750	350	225-300	A	4,1	40	40	28 pcs
44 60 64 042	750	350	375-450	A	4,9	65	40	20 pcs
44 60 64 030	800	500	400-475	B	8,2	126	55	18 pcs
44 60 64 020	1000	500	400-480	A	9,7	148	70	15 pcs

Nested bodies and separate lids

44 60 69 116	400	350	300-375	B	3,3	30	30	50 pcs
44 60 69 100	500	350	380-455	B	3,8	46	35	64 pcs
44 60 69 090	600	400	400-475	B	5,7	70	45	30 pcs
44 60 69 045	690	500	400-480	A	6,8	98	50	30 pcs
44 60 69 043	750	350	225-300	A	4,1	40	40	30 pcs
44 60 69 042	750	350	375-450	A	4,9	65	40	30 pcs
44 60 69 030	800	500	400-475	B	8,2	126	55	24 pcs
44 60 69 020	1000	500	400-480	A	9,7	148	70	20 pcs

*Indicated value is the maximum suggested distributed load using the dedicated LAGO support brackets

ORIGIN CUSTOMISATION

Silk screen printing, one or more colours, according to quantities

Laser printing, one colour

Logo maximum dimension according to toolbox/printing size

all dimensions are in mm

DAY TRIPPIN'

TOOL BOXES



UV stabilized polypropylene copolymer

Colour: black (UV stabilized)

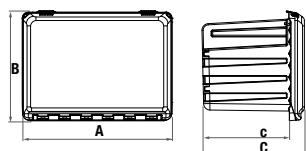

Scratch resistant proprietary surface
 Enveloping door, no water or dust introduction
 Traditional horizontal mounting (top or low opening), vertical (right or left opening) or standing (door top opening)
 Reinforcement ribs for impact and shock resistance
 Quick opening and closing system without handles
 Can be equipped with 2 padlocks or with LAGO key-locking system (with or without key)
 Transport and logistics optimization: can be delivered fully assembled or as separate nested parts, assembly of parts is easy and no tools are required
 Can be used as side protection device according to regulation ECE 73R01
 further details under download section www.lagoaccessori.it

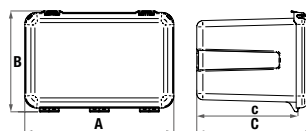

Fully assembled

Code	A	B	c-C	figure	kg	capacity (liters)	max load (kg)*	std packaging
44 60 60 116	400	350	300-350	B	2,8	30	30	40 pcs
44 60 60 100	500	350	380-450	B	3,4	46	35	40 pcs
44 60 60 090	600	400	400-470	B	4,9	70	45	30 pcs
44 60 60 045	690	500	400-470	A	5,9	98	50	20 pcs
44 60 60 030	800	500	400-470	B	6,4	126	55	18 pcs
44 60 60 020	1000	500	400-470	A	8,8	148	70	15 pcs

Nested bodies and separate lids

Code	A	B	c-C	figure	kg	capacity (liters)	max load (kg)*	std packaging
44 60 61 116	400	350	300-350	B	2,8	30	30	64 pcs
44 60 61 100	500	350	380-450	B	3,4	46	35	64 pcs
44 60 61 090	600	400	400-470	B	4,9	70	45	36 pcs
44 60 61 045	690	500	400-470	A	5,9	98	50	30 pcs
44 60 61 030	800	500	400-470	B	6,4	126	55	28 pcs
44 60 61 020	1000	500	400-470	A	8,8	148	70	24 pcs

*Indicated value is the maximum suggested distributed load using the dedicated LAGO support brackets

DAY TRIPPIN' CUSTOMISATION

Silk screen printing, one or more colours, according to quantities
 Laser printing, one colour
 Logo maximum dimension according to toolbox/printing size

all dimensions are in mm



SUPPORT BRACKET KITS

The use of dedicated LAGO mounting hardware and brackets is suggested to ensure optimum product performance
All support bracket kits are supplied with necessary hardware for tool box/bracket fastening

Steel S235JR

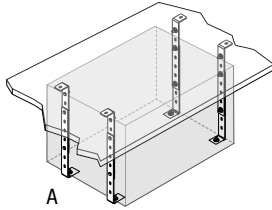

PLATFORM support bracket kits for **Black Dog** and **Vertigo**

Code	description	thickness	kg	fig.	std packaging
31 16 41 000	400/500 - adjustable height (only lateral brackets)	3	2,7	A	1 pair
31 16 43 030	600 - adjustable height	3	4,2	B	1 pair
31 16 43 040	700 - adjustable height	3	5,4	B	1 pair
31 16 43 045	750 - adjustable height	3	5	B	1 pair
31 16 43 050	800 - adjustable height	3	5,6	B	1 pair
31 16 43 060	1000 - adjustable height	3	6	B	1 pair

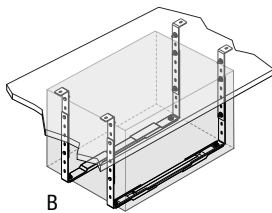

PLATFORM support bracket kits for **Mother Trucker**, **Origin** and **Day Trippin'**

Code	description	thickness	kg	fig.	std packaging
31 16 41 000	400/500 - adjustable height (only lateral brackets)	3	2,7	A	1 pair
31 16 42 030	600 - adjustable height	3	5	B	1 pair
31 16 69 040	700 - adjustable height	3	5,4	B	1 pair
31 16 42 050	800 - adjustable height	3	5,7	B	1 pair
31 16 69 060	1000 - adjustable height	3	6	B	1 pair

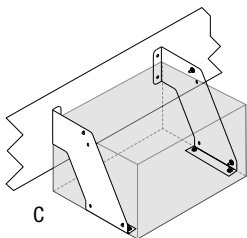

CHASSIS support bracket kits for **Black Dog** and **Vertigo**

Code	description	thickness	kg	fig.	std packaging
31 16 32 000	400/500 (only lateral brackets)	3	4,65	C	1 pair
31 16 34 030	600x470	3	9,7	D	1 pair
31 16 34 035	600x650	4	13,8	D	1 pair
31 16 34 037	600x550x650	4	15,8	D	1 pair
31 16 34 040	700	3	9,9	D	1 pair
31 16 34 043	700x650	4	13,8	D	1 pair
31 16 34 045	750	3	11	D	1 pair
31 16 34 050	800	3	10	D	1 pair
31 16 34 060	1000	3	10	D	1 pair
31 16 34 065	1000x650	4	16,8	D	1 pair

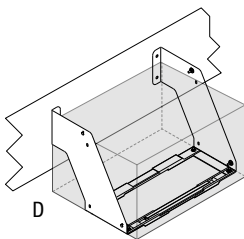

CHASSIS support bracket kits for **Mother Trucker**, **Origin** and **Day Trippin'**

Code	description	thickness	kg	fig.	std packaging
31 16 32 000	400/500 (only lateral brackets)	3	4,65	C	1 pair
31 16 33 030	600	3	7,6	D	1 pair
31 16 68 040	700	3	8,2	D	1 pair
31 16 68 046	750	3	8	D	1 pair
31 16 33 050	800	3	8	D	1 pair
31 16 68 060	1000	3	10	D	1 pair



DIVIDEA

DIVIDEA Polypropylene shelves and organizers for **Vertigo** 600/ 700/ 1000 and **Black Dog** 600/ 700/ 800/ 1000

Code	description	kg	fig.	std packaging
31 57 51 001	suitable for tool box 44 50 25 083 - 44 50 55 083	1,1	A	6 pcs
31 57 51 002	suitable for tool box 44 50 25 060 - 44 50 55 060	1,3	A	6 pcs
31 57 51 003	suitable for tool box 44 50 25 033 - 44 50 55 033	1,5	A	6 pcs
31 57 51 004	suitable for tool box 44 50 25 020 - 44 50 55 020	1,7	A	6 pcs

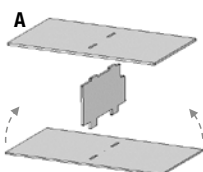

all dimensions are in mm

SPARE PARTS AND ACCESSORIES

Code	description	std packaging
07 09 08 010	 Pair of Origin 400 handles - mixed combinations Lever, key, spare key, key hole cap and screw kit included	pair
07 09 08 011	 Pair of Origin 500/600/700/800/1000 handles - mixed combinations Key, spare key, key hole cap and screw kit included	pair
07 09 08 012	 Pair of Black Dog handles - mixed combinations Lever, key, spare key, key hole cap and screw kit included	pair
07 09 08 013	 Pair of Vertigo / Mother Trucker handles - mixed combinations Key, spare key, key hole cap and screw kit included	pair
07 00 08 008	 Doorstop kit (L. 410) Mother Trucker - Origin - Day Trippin' 500-600	bulk
07 00 08 007	Doorstop kit (L. 610) Mother Trucker - Origin - Day Trippin' 700-1000	bulk
07 00 08 009	Doorstop kit (L. 610) Mother Trucker - Origin - Day Trippin' 800	bulk
05 57 08 022	 Inner flat loading panel (also suitable for lid) Mother Trucker - Origin - Day Trippin' 700	bulk
05 57 08 023	 Inner flat loading panel (also suitable for lid) Mother Trucker - Origin - Day Trippin' 1000	bulk
07 61 08 001	 Day Trippin' locking kit with key	6 pairs
07 61 08 002	 Day Trippin' locking kit without key	6 pairs

all dimensions are in mm

26





LAGO
made in Italy

TANKY
TANKYTOO

WATER TANKS

TANKY

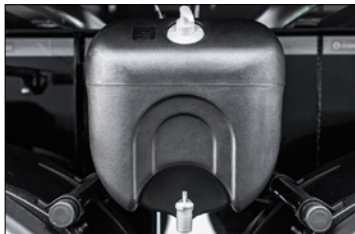
HAND WASH WATER TANK



UV stabilized polyethylene

Colour: black, white (UV stabilized)
not suitable for food stuff

Strong and handy

Threaded 250ml soap pump - Dispenser and tap included

Necessary hardware for Tanky/bracket fastening included

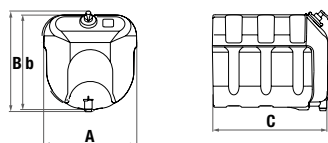

Tanky 30

Code	capacity (liters)	colour	A	b-B	C	kg	std packaging
52 55 15 010	28	White	350	360-380	430	3	60 pcs
52 50 15 030	28	Black	350	360-380	430	3	60 pcs

Tanky 50

52 55 15 050	45	White	420	430-450	450	5,2	45 pcs
52 50 15 050	45	Black	420	430-450	450	5,2	45 pcs

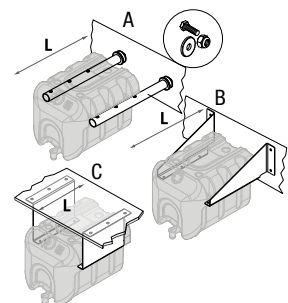

SUPPORT BRACKET KITS

Code	description	L	fig.	std packaging
31 16 28 001	Chassis mounting flanged tubes - Chassis mounting hardware supplies - Tanky/Tankytoo 30 and 50	466	A	multiple of 5
31 16 26 001	Chassis mounting fitting brackets - Tanky/Tankytoo 30 and 50	385	B	multiple of 5
31 16 25 001	Platform mounting fitting brackets - Tanky/Tankytoo 30 and 50	288	C	multiple of 5

SPARE PARTS

Code	description	fig.	std packaging
05 09 02 008	Soap dispenser kit (with tank)	A	bulk
05 09 02 009	Water tap	B	bulk
05 09 02 005	Tank cap (alternative to soap dispenser kit)	C	bulk

all dimensions are in mm

TANKYTOO

HAND WASH WATER TANK



UV stabilized polyethylene

Colour: black (UV stabilized)
not suitable for food stuff

Modern and handy
Threaded 250ml soap pump - Dispenser and tap included
Necessary hardware for Tankytoo/bracket fastening included

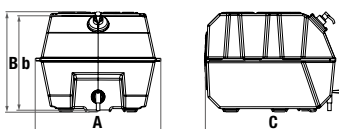

Code	capacity (liters)	colour	A	b-B	C	kg	std packaging
52 50 32 010	28	Black	382	283	400	2,8	42 pcs

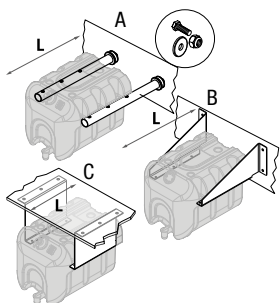

SUPPORT BRACKET KITS

Code	description	depth	fig.	std packaging
31 16 28 001	Chassis mounting flanged tubes - Chassis mounting hardware supplies - Tanky/Tankytoo 30 and 50	466	A	multiple of 5
31 16 26 001	Chassis mounting fitting brackets - Tanky/Tankytoo 30 and 50	385	B	multiple of 5
31 16 25 001	Platform mounting fitting brackets - Tanky/Tankytoo 30 and 50	288	C	multiple of 5

SPARE PARTS

Code	description	fig.	std packaging
05 09 02 008	Soap dispenser kit (with tank)	A	bulk
05 09 02 056	Water tap	B	bulk
05 09 02 005	Tank cap (alternative to soap dispenser kit)	C	bulk

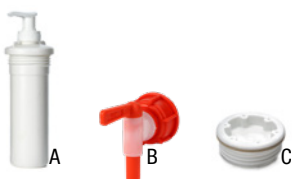

all dimensions are in mm

30



HOW MANY ROADS > 32

KOMPLEET KOMBI
KOMPLEET KOMBI TIPPER
PORTTER KOMBI
KOMPLEET
KOMPLEET KOMMA
WHEELMATE
WHEELMATE PRO
WHEELMATE PRO KOMPLEET
SPRAY BUSTER
QWIKLOK
BRACKETS AND FASTENING
TOOBEE
ROCK'N'ROAD
INTERFLEX

MUDGUARDS

>>

HOW MANY ROADS.

« I HAVE COME A LONG WAY. I HAVE SEEN STONES, SAND, RAIN, ICE, FOG, AND HOT ASPHALT. LONG JOURNEYS AND TERRAINS OF ALL KINDS HAVE MARKED MY HISTORY. »

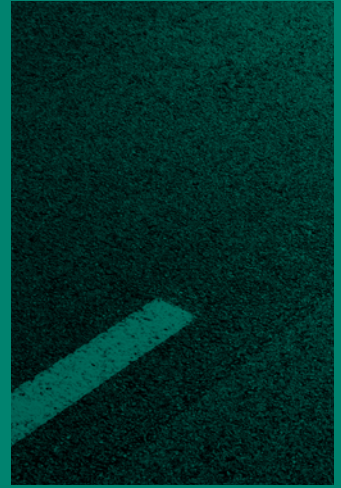
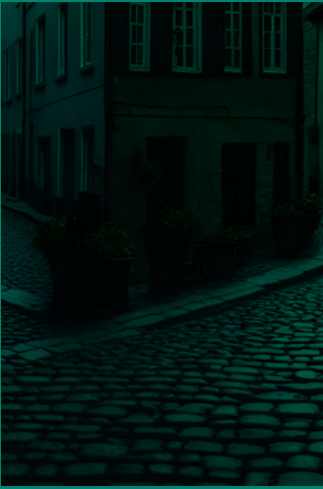

Of course, the focus has always been on her. "She marked the beginning of human civilization". She evolved to become the star of great sporting, hyper-technological, futuristic performances. In this modern world, she remains the queen. But without me, her protector, her work would be much more difficult.

I, a noble samurai, a proud knight, have been her solid armor for hundreds of years. I fended off the blows generated by her movement. The wheel in eternal rotation meets its large, reliable, and strong defense.

I have come a long way. I have seen stones, sand, rain, ice, fog, and hot asphalt. Long journeys and terrains of all kinds have marked my history. I have accompanied great transports, made memorable feats possible, and helped open new trajectories. From

generation to generation, traveling thousands of kilometers on the roads of the world. **My ancestors,** made of wood and metal, originally covered the wheels of wagons and carriages when roads were all mud and dust. With the arrival of bicycles, motorbikes, and cars, our shape was molded into increasingly slender lines. So much so that in Germany, we were called "**flügel**", **wings.** How elegant and refined that word is. Only we knew how to make debris and dirt fly away from passengers and bodywork, making the journey safer and more pleasant, always maintaining a sleek, streamlined style, enriching the means of transport with personality and character. Our sinuous curve guided the eye along metallic volumes. A touch of style was added. It became part of a motor vehicle's very identity, especially as design ventured into bolder, sleeker shapes.

Over time, like cloaks or lightly moving hoods, **antispray** appeared at our side. Our protection became more secure, more precise, our embrace more enveloping, picking up even the tiniest drops released into the air.

Every component around me has been ennobled on this long journey. The **tubes** needed to attach me to the frame have become more essential, easy to assemble and repair, resistant in their materials, aesthetic as well as functional. Because if something can be well made, why not make it?

In time, metal was joined **by plastic.** Today, my suit is studied and molded in every smallest detail: to be aerodynamic, efficient. Beautiful to look at, pleasant to the touch, more resistant to wear. Integrated into everything.

Designers, technicians, and engineers met to improve me. To make me an object that evolves over time. More precious. She and I continue to meet and are inseparable. She keeps on going. And I will continue to protect each of her new journeys.

And that dust and mud?
I'm proud of them.
They tell my story.

KOMPLEET KOMBI

MODULAR MUDGUARD WITH INTEGRATED
MUDFLAP, ANTISPRAY AND ADJUSTABLE BRACKETS

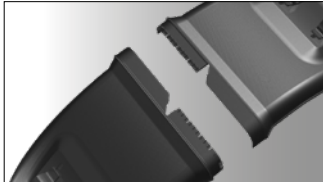
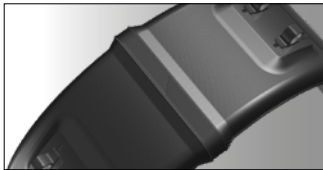

UV stabilized polypropylene copolymer

Colour: black and grey (UV stabilized)

Values on all fronts

4 different modules: Kombi Basic, Kombi 150, Kombi 250 and Kombi 350

50 / 75% less packed volume - Save on logistics, handling and storage

Simple assembly

No preliminary drilling, riveting, gluing or fastening operation

Substantial weight reduction through part integration

Scratch resistant proprietary surface

Adjustable Ø42 mm fixing eyelet - Max torque 12Nm

Eyelet clamping fasteners Geomet® surface treated - Extra corrosion resistant - Absence of other ferrous parts

Approved anti-spray device according to regulation (EU) 2021/535

further details under download section www.lagoaccessori.it

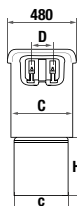
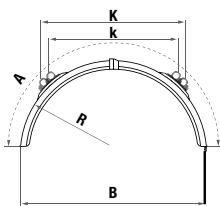

ASSEMBLED PRODUCT

Description	A	B	C-c	R	K	k	D	H mudflap
Kompleet Kombi without mudflap	1890	1290	450-390	640	925	803	150	-
Kompleet Kombi 150 - integrated mudflap 150mm	1890	1290	450-390	640	925	803	150	150
Kompleet Kombi 250 - integrated mudflap 250mm	1890	1290	450-390	640	925	803	150	250
Kompleet Kombi 350 - integrated mudflap 350mm	1890	1290	450-390	640	925	803	150	350

all dimensions are in mm

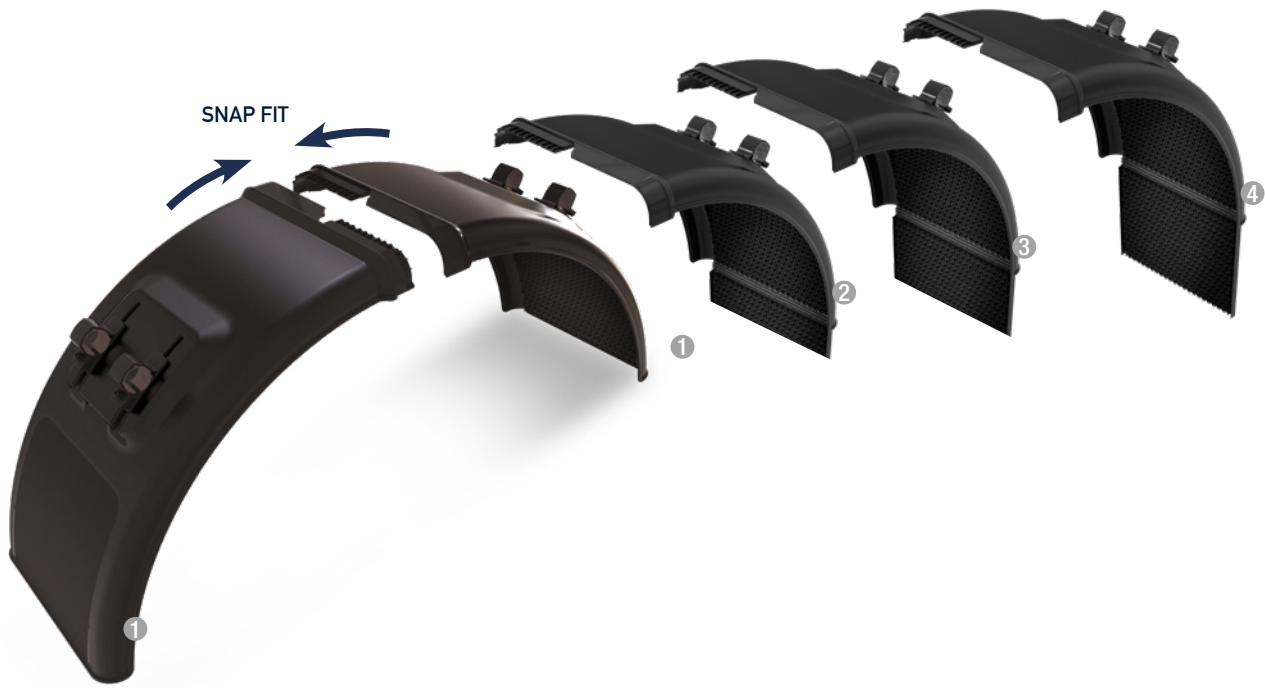

Compose your Kompleet Kombi combining the modules - All modules shipped dis-assembled

	Kompleet Kombi Basic = ① 15 60 45 010 + ① 15 60 45 010		
	Code	kg	std packaging
	① 15 60 45 010	2	18 pcs
	Kompleet Kombi 150 = ① 15 60 45 010 + ② 15 60 45 015		
	Code	kg	std packaging
	① 15 60 45 010	2	18 pcs
	Kompleet Kombi 250 = ① 15 60 45 010 + ③ 15 60 45 020		
	Code	kg	std packaging
	① 15 60 45 010	2	18 pcs
	Kompleet Kombi 350 = ① 15 60 45 010 + ④ 15 60 45 025		
	Code	kg	std packaging
	① 15 60 45 010	2	18 pcs
	Kompleet Kombi 150 = ② 15 60 45 015		
	Code	kg	std packaging
	② 15 60 45 015	2,25	18 pcs
	Kompleet Kombi 250 = ③ 15 60 45 020		
	Code	kg	std packaging
	③ 15 60 45 020	2,45	18 pcs
	Kompleet Kombi 350 = ④ 15 60 45 025		
	Code	kg	std packaging
	④ 15 60 45 025	2,65	18 pcs



MUDFLAP CUSTOMISATION

Silk screen printing
 Minimum order quantity required
 Maximum area for printing 330x190mm
 Nr. of colours to be evaluated

all dimensions are in mm

KOMPLEET KOMBI TIPPER

MODULAR MUDGUARD
WITH INTEGRATED FOLDABLE MUDFLAP

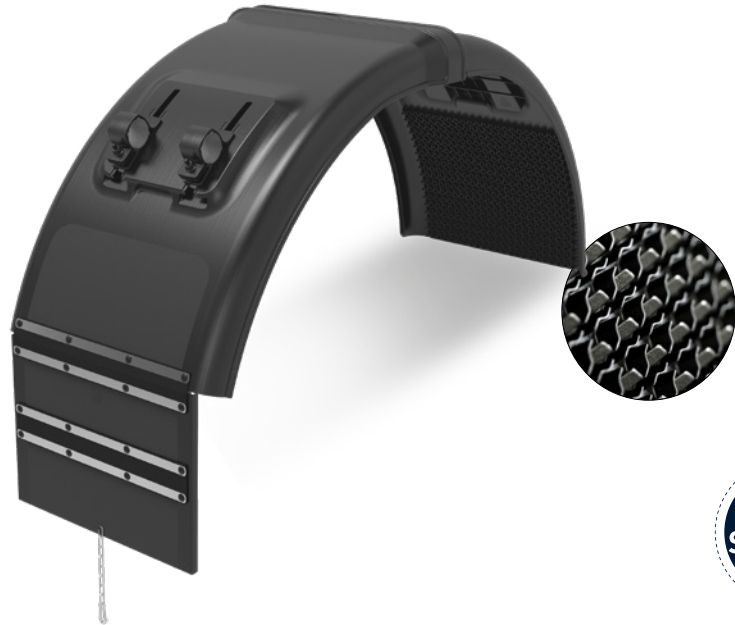

MUDGUARDS

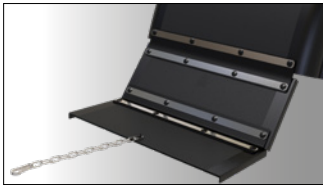
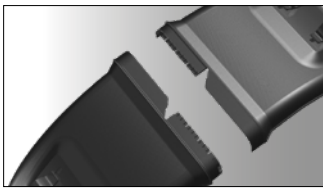

UV stabilized polypropylene copolymer

Colour: black (UV stabilized)

Dedicated solution for tipper trailers: ready for mounting mudguard with foldable mudflap, chain, carabiner for fixing to mudguards' pipes or rear bumpers

50 / 75% less packed volume - Save on logistics, handling and storage

Simple assembly - No tools required

No preliminary drilling, riveting, gluing or fastening operation

Substantial weight reduction through part integration

Scratch resistant proprietary surface

Adjustable Ø 42mm fixing eyelet - Max torque 12Nm

Eyelet clamping fasteners Geomet® surface treated - Extra corrosion resistant

Chain, carabiner, carabiner fixing eyelet, plates: stainless steel

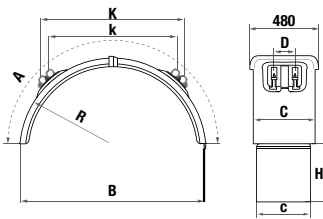

ASSEMBLED PRODUCT

Description	A	B	C-c	R	K	k	D	H
Kompleet Kombi Tipper	1800	1290	450-390	640	925	803	150	300



Kompleet Kombi Tipper = ① 15 60 45 010 + ⑤ 15 60 46 001

Code	kg	std packaging
① 15 60 45 010	2	18 pcs
⑤ 15 60 46 001	2,8	18 pcs

all dimensions are in mm

PORTTER KOMBI

BROOM, SHOVEL AND LADDER HOLDER

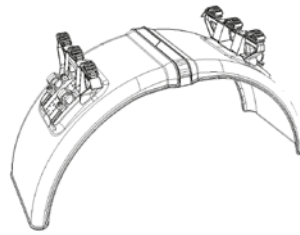
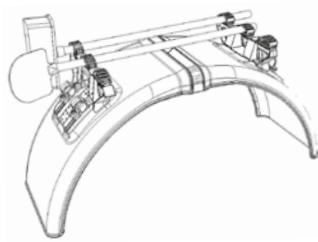

PA6 GF + rubber

Colour: black

Lighter, Faster, Better
Simple and fast assembly
Substantial weight reduction
Necessary hardware for fastening to mudguard included
Extra corrosion resistant

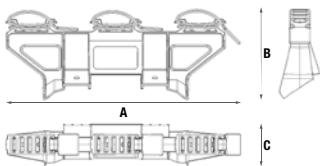

Portter Kombi

Code	A	B	C	kg	std packaging
72 60 40 002*	425	170	80	0,66	4 pcs

*3 rubber fasteners (050702049) included

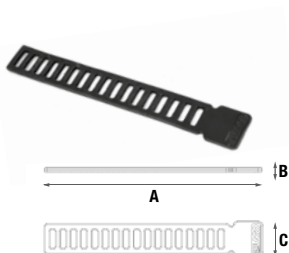

Spare parts - Rubber Portter fastener

Code	A	B	C	kg	std packaging
05 07 02 049	290	5	45	0,05	12 pcs

all dimensions are in mm

KOMPLEET

INTEGRATED MUDFLAP, ANTI-SPRAY AND ADJUSTABLE BRACKETS



UV stabilized polypropylene copolymer

Colour: black (UV stabilized)

- Fully integrated system - Increased reliability and quicker mounting
- Simple assembly
- No preliminary drilling, riveting, gluing or fastening operation
- Substantial weight reduction through part integration
- Scratch resistant proprietary surface
- Adjustable Ø42 mm fixing eyelet - Max torque 12Nm
- Eyelet clamping fasteners Geomet® surface treated - Extra corrosion resistant - Absence of other ferrous parts

Approved anti-spray device according to regulation (EU) 2021/535
further details under download section www.lagoaccessori.it

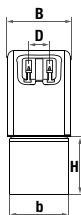
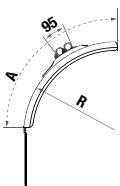

Code	A	B-b	R	D	H mudflap	kg	std packaging
15 60 01 008	700	450-390	670	150	-	1,78	48 pcs
15 60 10 170	700	450-390	670	150	160	2,75	42 pcs
15 60 11 170	700	450-390	670	150	250	3	30 pcs
15 60 12 170	700	450-390	670	150	350	3,5	30 pcs
15 60 09 170	700	450-390	670	150	300	3	30 pcs



MUDFLAP CUSTOMISATION

- Silk screen printing
- Minimum order quantity required
- Maximum area for printing 330x190mm
- Nr. of colours to be evaluated

all dimensions are in mm

KOMPLEET KOMMA

VERTICAL MUDGUARDS,
INTEGRATED MUDFLAP AND ANTISPRAY DEVICE



UV stabilized polypropylene copolymer

Colour: black (UV stabilized)

Fully integrated semi-trailer mudguard - Quicker mounting and lateral mudflap ready
No preliminary drilling, riveting, gluing or fastening necessary
Scratch resistant proprietary surface
Extra corrosion resistant - Absence of ferrous parts
Integrated wind proof hinge
Integrated mounting holes

Approved anti-spray device according to regulation (EU) 2021/535
further details under download section www.lagoaccessori.it

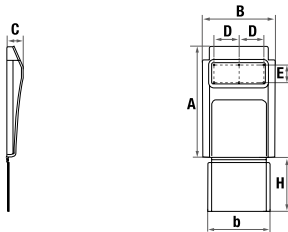

Code	A	B-b	C	D	E	H mudflap	kg	std packaging
15 60 40 010	735	470-410	110	165	116	-	1,8	20 pcs
15 60 40 018	735	470-410	110	165	116	190	2,2	18 pcs
15 60 40 020	735	470-410	110	165	116	265	2,3	18 pcs
15 60 40 025	735	470-410	110	165	116	350	2,4	18 pcs
15 60 39 025	620	480-410	110	165	116	290	3,0	18 pcs



MUDFLAP CUSTOMISATION

Silk screen printing
Minimum order quantity required
Maximum area for printing 330x190mm
Nr. of colours to be evaluated

all dimensions are in mm

WHEELMATE

MUDGUARDS



UV stabilized polypropylene copolymer

Colour: black (UV stabilized)

A mudguard for every application
Scratch resistant proprietary surface

Conventional mudguards

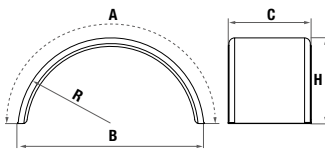

Code	A	B	C	H	P	R	kg	std packaging
11 60 41 380	2100	1340	660	670		670	6,1	42 pcs
11 60 41 410	2100	1350	440	670		670	4,2	60 pcs
11 60 41 460	1920	1310	450	600		650	3,5	60 pcs
11 60 41 505	1700	1100	560	540		550	3,5	50 pcs
11 60 41 535	1580	1000	550	510		500	3	60 pcs
11 60 41 540	1580	1000	500	500		500	2,8	80 pcs
11 60 41 640	1400	900	450	450		450	2,3	80 pcs
11 60 41 643	1400	900	270	450		450	1,2	10 pcs
11 60 41 655	1380	890	400	440		440	2	100 pcs

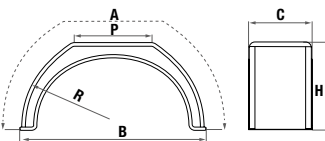

Flat top mudguards

11 60 42 610	1470	910	460	460	390	500	2,6	80 pcs
11 60 42 600	1500	900	310	480	400	600	2,4	90 pcs
11 60 42 509	1750	1000	510	550	510	650	3,6	80 pcs



Quarter mudguards

11 60 40 080	1000	-	660	-		670	3	24 pcs
11 60 40 095	1000	-	440	-		670	2	24 pcs
11 60 40 130	800	-	670	-		670	2,1	50 pcs
11 60 40 145	810	-	440	-		670	1,5	50 pcs
11 60 40 155	700	-	670	-		670	2	50 pcs
11 60 40 170	700	-	440	-		670	1,4	50 pcs
11 60 01 010	640	-	720	-		640	2	50 pcs



SIDE EDGE CUSTOMIZATION

Hot transfer printing
Minimum order quantity required
Maximum area for printing 68x15mm

all dimensions are in mm

WHEELMATE PRO

MUDGUARDS WITH PRE ASSEMBLED ADJUSTABLE BRACKETS



UV stabilized polypropylene copolymer

Colour: black (UV stabilized)

Wheelmate mudguards with pre assembled brackets

Scratch resistant proprietary surface

Adjustable \varnothing 42mm fixing eyelet for conventional mudguards - Max torque 12Nm

Adjustable \varnothing 42mm non slip fixing eyelet for quarter mudguards - Max torque 15Nm

Qwiklok versions available upon request

Conventional mudguard with preassembled brackets 57 05 18 010

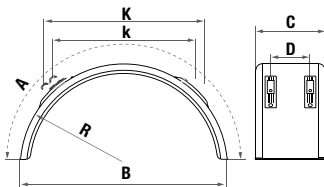

Code	A	B	C	R	K	k	D	kg	mpb*
11 60 46 380	2100	1340	660	670	970	790	450	7,6	36 pcs
11 60 46 410	2100	1350	440	670	970	790	250	5,7	48 pcs
11 60 46 465	1900	1330	650	670	985	805	450	7,3	36 pcs
11 60 46 460	1940	1310	450	650	1010	850	250	5	48 pcs
11 60 46 505	1700	1100	560	550	920	720	350	5	48 pcs
11 60 46 535	1580	1000	550	500	810	600	350	4,5	48 pcs
11 60 46 540	1580	1000	500	500	810	600	350	4,3	60 pcs
11 60 46 640	1400	900	450	450	690	510	250	3,8	60 pcs
11 60 46 655	1380	890	400	440	670	495	225	3,5	72 pcs

*Minimum production batch



Quarter mudguard with preassembled brackets 57 05 17 010

Code	A	B	C	R	K	k	D	kg	mpb*
11 60 45 130	800	-	670	670	-	-	450	2,9	32 pcs
11 60 45 145	810	-	440	670	-	-	250	2,2	32 pcs
11 60 45 155	700	-	670	670	-	-	450	2,6	32 pcs
11 60 45 170	700	-	440	670	-	-	250	1,9	32 pcs
11 60 01 037	640	-	720	640	-	-	525	2,4	32 pcs

*Minimum production batch



SIDE EDGE CUSTOMIZATION

Hot transfer printing

Minimum order quantity required

Maximum area for printing 68x15mm

all dimensions are in mm

WHEELMATE PRO KOMPLEET

MUDGUARDS WITH PRE ASSEMBLED
ADJUSTABLE BRACKETS AND MUDFLAP



QWIKLOK
COMPATIBILITY

MUDGUARDS



UV stabilized polypropylene copolymer

Colour: black (UV stabilized)

Wheelmate Pro Mudguards with pre assembled Spray Buster mudflap

Scratch resistant proprietary surface

Adjustable Ø 42mm fixing eyelet for conventional mudguards - Max torque 12Nm

Adjustable Ø 42mm non slip fixing eyelet for quarter mudguards - Max torque 15Nm

Qwiklok versions available upon request

Approved anti-spray device according to regulation (EU) 2021/535
further details under download section www.lagoaccessori.it

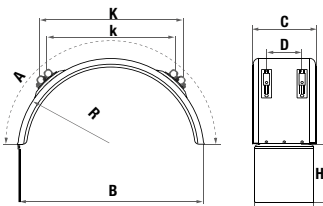

Conventional mudguard + preassembled brackets 57 05 18 010 + internal antispray + mudflap

Code	A	B	C-c	R	K	k	D	H mudflap	kg	mpb*
14 60 35 380	2100	1340	660-604	670	970	790	450	400	9	24 pcs
14 60 35 410	2100	1350	440-412	670	970	790	250	400	6,3	40 pcs
14 60 35 465	1900	1330	650-604	670	985	805	450	400	8,5	24 pcs
14 60 35 460	1940	1310	450-412	650	1100	850	250	400	5,9	40 pcs
14 60 35 505	1700	1100	560-508	500	920	720	350	400	6,7	36 pcs

*Minimum production batch

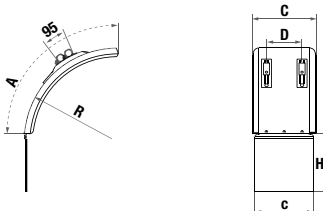

Quarter mudguard + preassembled brackets 57 05 17 010 + mudflap

Code	A	B	C-c	R	K	k	D	H mudflap	kg	mpb*
14 60 30 130	800	-	670-604	670	-	-	450	400	2,1	18 pcs
14 60 30 145	810	-	440-412	670	-	-	250	400	3	18 pcs
14 60 30 155	700	-	670-604	670	-	-	450	400	3,5	18 pcs
14 60 30 170	700	-	440-412	670	-	-	250	400	2,9	18 pcs

*Minimum production batch



MUDFLAP CUSTOMISATION

Silk screen printing

Minimum order quantity required

Maximum area for printing 330x190mm

Nr. of colours to be evaluated



SIDE EDGE CUSTOMIZATION

Hot transfer printing

Minimum order quantity required

Maximum area for printing 68x15mm

all dimensions are in mm

SPRAY BUSTER

MUDFLAPS WITH ANTI-SPRAY

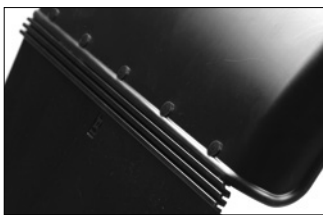

UV stabilized polypropylene copolymer

Colour: black (UV stabilized)

Mudflap with homologated anti-spray device
3 sizes
Scratch resistant proprietary surface
Supplied with mudflap/mudguard mounting fasteners

Approved anti-spray device according to regulation (EU) 2021/535
further details under download section www.lagoaccessori.it

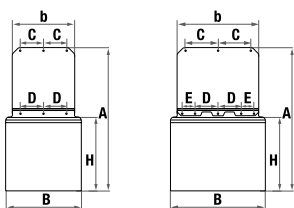

Code	A	b-B	H mudflap	C	D	E	kg	std packaging
12 60 64 210	780	340-412	400	127	125	-	1,6	12 pcs
12 60 64 215	780	436-508	400	175	125	68	2	12 pcs
12 60 64 220	780	532-604	400	223	125	117	2,4	12 pcs



MUDFLAP CUSTOMISATION

Silk screen printing
Minimum order quantity required
Maximum area for printing 330x190mm
Nr. of colours to be evaluated

all dimensions are in mm

QWIKLOK

MUDGUARD FITTING BRACKETS

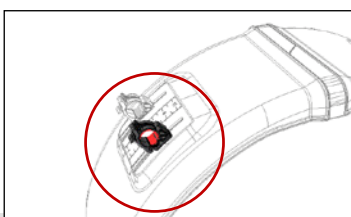
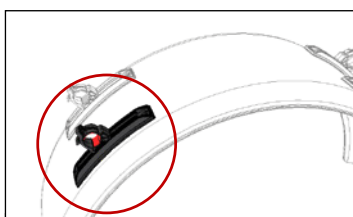

Nylon GF - Epdm rubber PA6

Colour: black - red (UV stabilized)

Qwiklok mudguard mounting eyelet & bracket system
 Quick, effective and smart fastening / assembly solution without fixing hardware
 Assembly time 50% quicker compared to traditional systems with hardware
 Fits Ø 42mm tubes
 Fully adjustable
 Supplied rail/mudgard with mounting screws, nuts and washers
 Bottom or frontal mounting



QWIKLOK
COMPATIBILITY

Check compatibility of Qwiklok system on mudguards families:

- Wheelmate Pro at page 41
- Wheelmate Pro Kompleet at page 42



Mudguard fitting brackets

Code	description	mat/finishing	std packaging
57 60 40 010	Qwiklok bracket	UV Stabilized copolymer polypropylene GF - Nylon GF - Epdm rubber PA6	48 pcs

Fixing eyelet

Code	description	mat/finishing	std packaging
05 05 02 028	Qwiklok eyelet	Nylon GF - Epdm rubber	12 pcs

MOUNTINGS

Frontal mounting



Mounting from the bottom



all dimensions are in mm

SARÀKA

MUDGUARD QUICK FASTENING KIT



UV stabilized acetalic resin

Colour: black (UV stabilized)

Fully adjustable pair of mudguard quick fastening brackets
 Provides unlimited left and right adjustment, guarantees perfect ground alignment and lining up with adjacent mudguards
 No preliminary drilling, riveting, glueing or fastening necessary
 Assembly time 50% quicker compared to traditional systems
 No tube end caps required
 Fits Ø 42mm tubes
 Customisation ready - Plastic laminated reflective adhesive label - Four colour process print - Minimum order and production requirement



Code	description	std packaging
57 05 35 010	Saràka Ø 42mm brackets - Hardware included	12 pairs

Saràka is designed to be used exclusively with LAGO Wheelmate mudguards:
 11 60 41 380 - 11 60 41 410 - 11 60 41 465 - 11 60 41 460

MUDGUARD FITTING BRACKETS

UV stabilized copolymer polypropylene - Epdm rubber - Acetalic resin - Steel - Stainless steel
 Eyelet clamping fasteners Geomet® surface treated

All brackets are supplied with mounting screws, nuts and washers

Mudguard fitting brackets - Suitable for quarter mudguards

Code	description	mat/finishing	std packaging
57 05 17 010	Adjustable bracket Ø 42mm - Hardware included Non slip fixing eyelet - Max torque 15Nm	PA6 Nylon GF PA6 Nylon GF - Epdm Rubber	48 pcs

Mudguard fitting brackets - Suitable for conventional mudguards

Code	description	PA6 Nylon GF	std packaging
57 05 18 010	Adjustable bracket Ø 42mm - Hardware included Fixing eyelet - Max torque 12Nm	PA6 Nylon GF	48 pcs

Mudguard fitting brackets - Suitable for conventional mudguards

Code	description	Acetalic resin PA6 Nylon GF	std packaging
57 05 15 005	Adjustable bracket Ø 34mm - Hardware included Fixing eyelet	Acetalic resin PA6 Nylon GF	48 pcs

Fixing eyelet

Code	description	mat/finishing	fig.	std packaging
05 05 02 014	Adjustable non-slip fixing eyelet - Ø 42mm	PA6 Nylon GF - Epdm Rubber	A	12 pcs
05 05 02 016	Adjustable fixing eyelet - Ø 42mm	PA6 Nylon GF	B	12 pcs
05 05 02 021	Adjustable fixing eyelet - Ø 34mm	PA6 Nylon GF	C	12 pcs

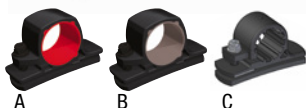

Code	description	Ø	mat/finishing	std packaging
57 05 10 010	Fixed bracket	42	Acetalic resin	100 pcs
57 05 10 015	Fixed bracket	48	Acetalic resin	100 pcs
57 05 10 020	Fixed bracket	54	Acetalic resin	100 pcs
57 11 30 010	Fixed Metal steel bracket	42	Steel - Galvanized	50 pcs
57 11 30 020	Fixed Metal steel bracket	54	Steel - Galvanized	50 pcs
57 11 15 010	Adjustable steel bracket	42	Steel - Galvanized	50 pcs
57 16 15 010	Adjustable steel bracket	42	Steel - Black epoxy coating	50 pcs
57 30 15 010	Adjustable stainless steel bracket	42	Stainless steel	50 pcs

all dimensions are in mm

TOOBEE STEEL

MUDGUARD BRACKETING PIPE



Steel FE320 - UV stabilized polyethylene endcap included

The most recent generation of mudguard stay, TooBee represents a fresh new look at mudguard mounting hardware. The weld free monolithic approach for this patented component implies greater resistance to mechanical stress and to material fatigue deriving from cyclic loading. Unparalleled corrosion resistance is achieved through the absence of surface weld impurity and the fluidity in surface forming.

TooBee is supplied with the endcap preassembled and individual mounting hardware kit is included. TooBee can be galvanized or finished with a double coating (galvanized/KTL + black powder coating).

Steel-Galvanized

Code	Ø	thickness	L	A	B	C	D	std packaging
16 11 01 034	42	2	811	-	-	-	-	12 pcs
16 11 31 360	42	2	750	-	-	-	-	12 pcs
16 11 31 375	42	2	600	-	-	-	-	12 pcs
18 11 01 033	42	2	811	87	170	105	95	12 pcs
18 11 31 365	42	2	730	87	170	105	95	12 pcs
18 11 31 380	42	2	580	87	170	105	95	12 pcs

KTL / Stell-Galvanized + Black Epoxy Coating

Code	Ø	thickness	L	A	B	C	D	std packaging
16 20 01 120	42	2	811	-	-	-	-	12 pcs
16 41 31 360	42	2	750	-	-	-	-	12 pcs
16 41 31 375	42	2	600	-	-	-	-	12 pcs
18 20 01 010	42	2	811	87	170	105	95	12 pcs
18 41 31 365	42	2	730	87	170	105	95	12 pcs
18 41 31 380	42	2	580	87	170	105	95	12 pcs

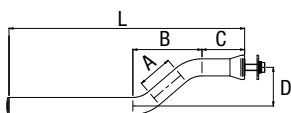
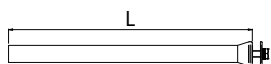
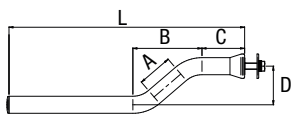
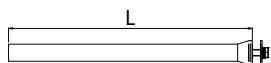

all dimensions are in mm

TOOBEE ALU / STAINLESS STEEL

MUDGUARD BRACKETING PIPE

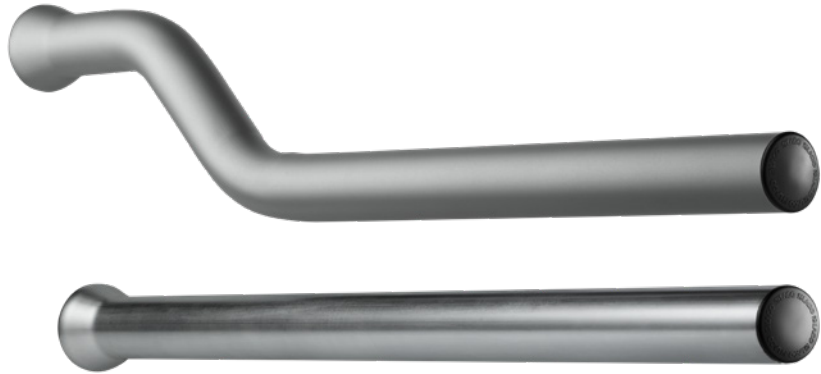

Aluminium - Stainless steel - UV stabilized polyethylene endcap included

The most recent generation of mudguard stay, TooBee represents a fresh new look at mudguard mounting hardware. The weld free monolithic approach for this patented component implies greater resistance to mechanical stress and to material fatigue deriving from cyclic loading. Unparalleled corrosion resistance is achieved through the absence of surface weld impurity and the fluidity in surface forming.

TooBee is supplied with the endcap preassembled and individual mounting hardware kit is included.

Stainless Steel

Code	Ø	thickness	L	A	B	C	D	std packaging
16 30 31 353	42	2	811	-	-	-	-	12 pcs
16 30 31 360	42	2	750	-	-	-	-	12 pcs
16 30 31 375	42	2	600	-	-	-	-	12 pcs

18 30 31 353	42	2	811	87	170	105	95	12 pcs
18 30 31 365	42	2	730	87	170	105	95	12 pcs
18 30 31 380	42	2	580	87	170	105	95	12 pcs

Anodized Aluminium

Code	Ø	thickness	L	A	B	C	D	std packaging
16 49 33 353	42	3	811	-	-	-	-	12 pcs
16 49 33 360	42	3	750	-	-	-	-	12 pcs
16 49 33 375	42	3	600	-	-	-	-	12 pcs

18 49 33 353	42	3	811	87	170	105	95	12 pcs
18 49 33 365	42	3	730	87	170	105	95	12 pcs
18 49 33 380	42	3	580	87	170	105	95	12 pcs

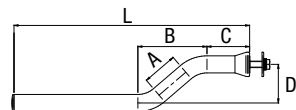
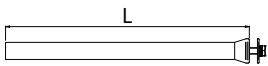
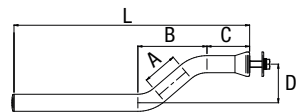
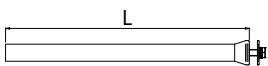

MOUNTING TUBES

Steel S235JR - Stainless steel AISI 304 2B



Different dimensions and finishing available upon request
Tube end cap not included



Code	description	Ø	thickness	length	finishing	std packaging
16 11 10 020	Straight tube	42	2	750	Steel- Galvanized	14 pcs
16 11 20 020	Straight tube	54	2	750	Steel- Galvanized	14 pcs
16 11 10 200	Straight tube - square flange	42	2	750+5 (flange)	Steel- Galvanized	12 pcs
16 11 01 007	Straight tube - reinforced rectangular flange	42	2	750+5 (flange)	Steel- Galvanized	10 pcs
17 11 10 015	Bent tube	42	2	770	Steel- Galvanized	12 pcs
17 11 20 015	Bent tube	54	2	770	Steel- Galvanized	8 pcs
18 30 10 025	Double bent tube	42	2	730	Stainless Steel	12 pcs
16 20 01 119	Straight tube - round flange*	34	3	660	Steel-Black epoxy coating	12 pcs
16 20 01 113	Straight tube - triangular flange*	34	3	660	Steel-Black epoxy coating	12 pcs
16 20 01 117	Double bent tube - round flange*	34	3	560	Steel-Black epoxy coating	12 pcs
18 20 01 012	Double bent tube - round flange*	34	3	775	Steel-Black epoxy coating	12 pcs

*with welded hardware

TUBE END CAPS

UV stabilized polyethylene



Code	description	std packaging
05 09 02 060	Tube end cap Ø 34mm	bulk
05 09 02 003	Tube end cap Ø 42mm	bulk
05 09 02 002	Tube end cap Ø 48mm	bulk
05 09 02 001	Tube end cap Ø 54mm	bulk

MUDGUARD FITTING KITS

Steel S235JR

Straight tube + 1 welded fixed bracket + 1 moveable fixed bracket (tube end cap not included)
Different dimensions and finishing available upon request



Code	Ø	thickness	length	finishing	std packaging
24 11 12 035	42	2	600	Galvanized	10 pcs
24 11 12 020	42	2	750	Galvanized	10 pcs
24 11 22 020	54	2	750	Galvanized	10 pcs

FLANGED TUBE CLAMPS

Steel S235JR - Clamps thickness 2,5mm - Flange thickness 6mm

Different dimensions and finishing available upon request



Code	description	finishing	std packaging
56 11 15 010	Tube fitting Ø 42mm - round flange	Galvanized	20 pcs
56 11 20 010	Tube fitting Ø 42mm - square flange	Galvanized	60 pcs
56 11 20 020	Tube fitting Ø 54mm - square flange	Galvanized	50 pcs
56 11 25 020	Reinforced tube fitting Ø 54 mm - square flange	Galvanized	50 pcs

Nylon GF

Code	description	std packaging
56 05 30 010	Tube fitting Ø 42mm	50 pcs

all dimensions are in mm

ROCK'N'ROAD

MUDGUARDS FOR SPECIAL VEHICLES



Steel - Stainless steel - Aluminium tread plate

Different dimensions, finishing and thickness available upon request

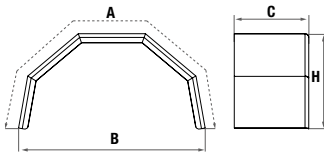

Code	description	A	B	C	thickness	H	mpb*
10 25 25 360	Steel	2300	1400	650	1,8	700	10 pcs
10 30 25 360	Stainless steel	2300	1400	650	1,5	700	10 pcs
10 32 25 360	Flowered stainless steel	2300	1400	650	1,5	700	10 pcs
10 46 25 360	Aluminium tread plate	2300	1400	650	3+2	700	10 pcs

*Minimum production batch

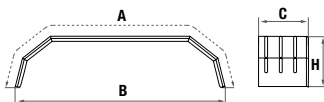

Code	description	A	B	C	thickness	H	mpb*
10 25 26 315	Steel	3500	2740	650	1,8	660	10 pcs
10 30 26 315	Stainless steel	3500	2740	650	1,5	660	10 pcs
10 32 26 315	Flowered stainless steel	3500	2740	650	1,5	660	10 pcs
10 46 26 315	Aluminium tread plate	3500	2740	650	3+2	660	10 pcs

*Minimum production batch

all dimensions are in mm

INTERFLEX

GALVANIZED STEEL / STAINLESS STEEL MUDGUARDS WITH RUBBER EDGE SINGLE AND MULTI AXLE

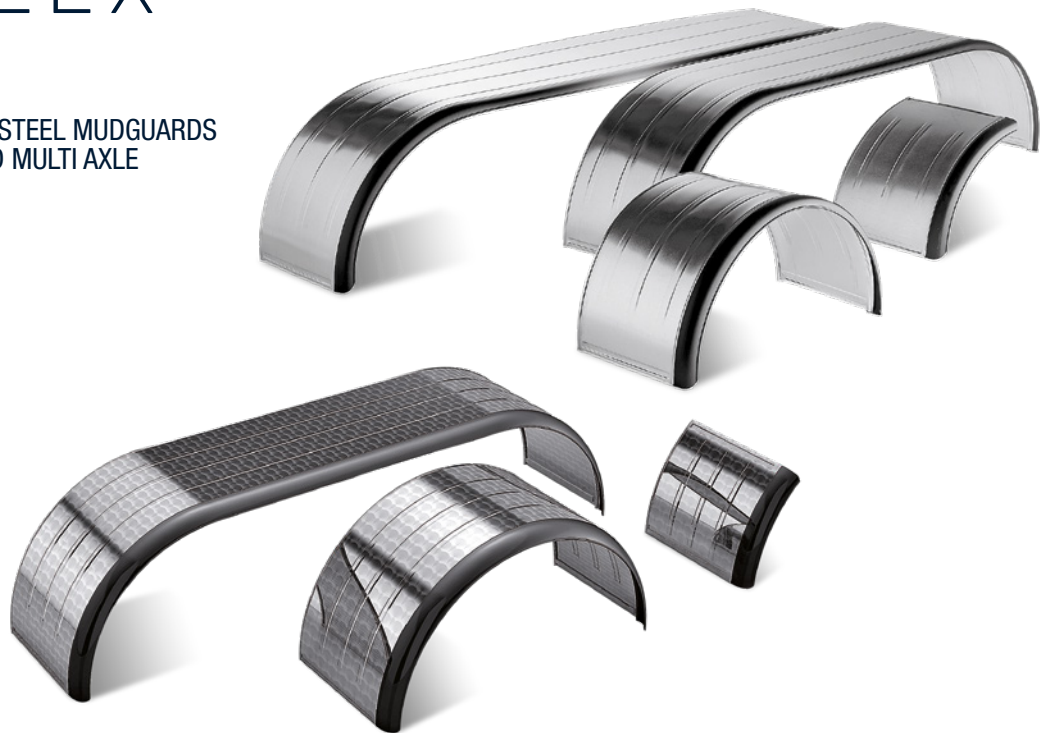

MUDGUARDS



ZG Galvanized steel

Thickness: 0,8mm
Rubber edge: 60mm or 90mm



IFG Machine turned finish stainless steel AISI 304 2B

Thickness: 0,8 mm
Rubber edge: 90 mm

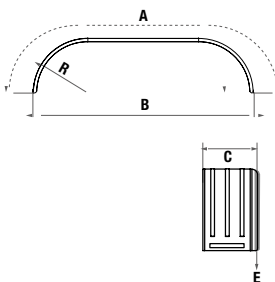

Tandem mudguards

ZG Code	E	IFG Code	E	A	B	C	R	mpb*
10 13 11 315	90	10 33 11 305	90	3550	2740	650	670	10 pcs
10 13 11 310	90	10 33 11 310	90	3550	2740	600	670	10 pcs
10 13 11 335	90	10 33 11 335	90	3450	2640	650	670	10 pcs
10 13 11 340	90	10 33 11 340	90	3450	2640	600	670	10 pcs

*Minimum production batch

all dimensions are in mm

INTERFLEX

MUDGUARDS WITH RUBBER EDGE SINGLE AND MULTI AXLE

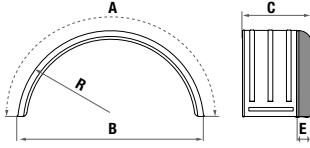

Single axle mudguards

ZG Code	E	IFG Code	E	A	B	C	R	mpb*
10 13 11 380	90	10 33 11 380	90	2100	1340	650	670	10 pcs
10 13 11 400	90	10 33 11 400	90	2100	1340	450	670	10 pcs
10 13 11 435	90	10 33 11 435	90	2000	1260	550	630	10 pcs
10 13 11 485	90	10 33 11 485	90	1800	1170	650	585	10 pcs
10 13 11 490	90	10 33 11 490	90	1800	1170	600	585	10 pcs
10 13 21 515	60	10 33 11 515	90	1700	1100	550	550	10 pcs
10 13 21 560	60	10 33 11 560	90	1570	1000	550	500	10 pcs
10 13 21 565	60	10 33 11 565	90	1570	980	500	490	10 pcs
10 13 21 570	60	10 33 11 570	90	1570	980	450	490	10 pcs
10 13 21 625	60	10 33 11 625	90	1450	880	400	440	10 pcs
10 13 21 630	60	10 33 11 630	90	1450	880	270	440	10 pcs
10 13 21 670	60	10 33 11 670	90	1360	850	450	425	10 pcs
10 13 21 675	60	10 33 11 675	90	1360	850	400	425	10 pcs
10 13 21 700	60	10 33 11 700	90	1250	800	250	400	10 pcs

*Minimum production batch

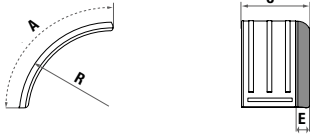

Quarter mudguards

ZG Code	E	IFG Code	E	A	B	C	R	mpb*
10 13 20 080	60	10 33 10 080	90	1000	-	650	670	20 pcs
10 13 20 130	60	10 33 10 130	90	800	-	650	650	20 pcs
10 13 20 135	60	10 33 10 135	90	800	-	600	650	20 pcs
10 13 20 155	60	10 33 10 155	90	700	-	650	650	20 pcs
10 13 20 160	60	10 33 10 160	90	700	-	600	650	20 pcs
10 13 20 165	60	10 33 10 165	90	700	-	500	650	20 pcs
10 13 20 185	60	10 33 10 185	90	650	-	650	650	20 pcs
10 13 20 200	60	10 33 10 200	90	600	-	650	650	20 pcs
10 13 20 205	60	10 33 10 205	90	600	-	600	630	20 pcs
10 13 20 210	60	10 33 10 210	90	600	-	500	630	20 pcs

*Minimum production batch

Different dimensions, finishing and thickness available upon request:

- galvanised steel 0,8mm - 1mm - 1,2mm
- stainless steel AISI 3042B 0,8mm - 1mm
- machine turned finish stainless steel 0,8mm - 1mm
- polished stainless steel 0,8mm - 1mm

52

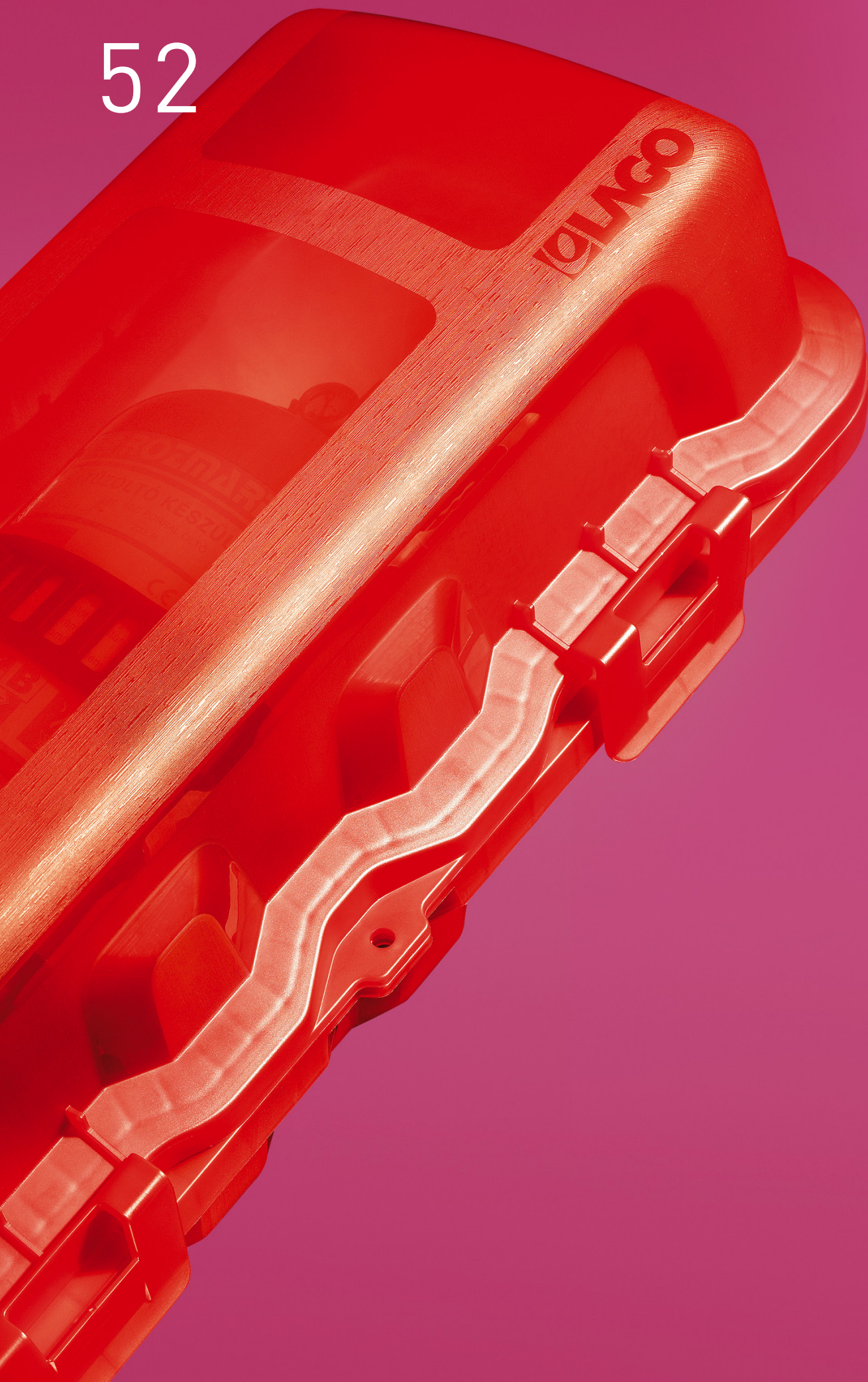

LIMITLESS:
A STORY OF SELF-ESTEEM > 54

SHELLY
SHELLY SOLID RED
FITEASY
RELEASEY
FOLPY
SLYKÒN
GRABBY

SAFETY & HYGIENE

>>

LIMITLESS: A STORY OF SELF-ESTEEM.



Yes, I know what you're thinking. That someone with a job like mine shouldn't have too many distractions. No complexities. Just someone who gets straight to the point. Some might think that certain issues for me are "off-topic". After all, I'm always expected to be straightforward and intuitive. No complications.

But there's one thing I've learned over the years: why limit yourself? Even I didn't believe that. Yet, when ingenuity is put to work,

the effects can be quite surprising. Creativity can play its part where we least expect it. Now, I too can be associated with the word "design". Let me tell you more: looking at me today, you can talk about ergonomics. It means that my form, my parts, are specifically designed for fluid gestures, contributing to the well-being of those who work with me.

There's something else that makes a real difference. Now I have many looks,

many faces. It's not just about taste; it's certainly not vanity. Each form I take is suited to a particular situation. Every material I'm made from has its own installation conditions. For each of my designs, there's an ideal context. Small or large spaces. Vertical or horizontal. Different opening systems, depending on the available space and the position I need to occupy. And with straps to handle even the toughest vibrations. I can, even when designed

to, function as a side guard. Not everyone can do that.

From now on, I won't be shy, the one everyone thinks is closed off. I won't be just "the strong one". From now on, call me "elegant and intelligent". Because I deserve it.



«FROM NOW ON, I WON'T BE SHY,
THE ONE EVERYONE THINKS
IS CLOSED OFF. I WON'T BE JUST
"THE STRONG ONE".
FROM NOW ON, CALL ME "ELEGANT
AND INTELLIGENT".
BECAUSE I DESERVE IT.»

SHELLY

FIRE EXTINGUISHER BOX



UV stabilized polypropylene copolymer

Colour: red translucent (UV stabilized)



Suitable for 6kg fire extinguishers

Red translucent finish allows immediate identification of the extinguisher for the purpose of visual inspection.

Water and dust resistance provided by integrated sealing and coupling features in lid.

Quick release latches ensure prompt opening of the lid in case of an emergency.

The unique fire extinguisher retention system mounts directly to the vehicle whilst the fire extinguisher outer case becomes a non-structural protective element for the extinguisher itself.

Adjustable and extensible high-resistance elastomer retention straps.

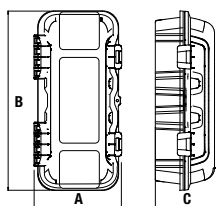

Code	extinguisher	extinguisher Ø min-max	A	B	C	kg	std packaging
49 61 45 010	6kg	150-170	305	627	220	1,9	18/126 pcs

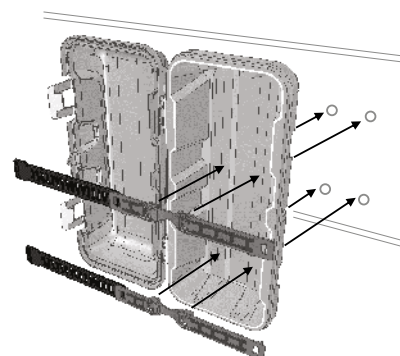
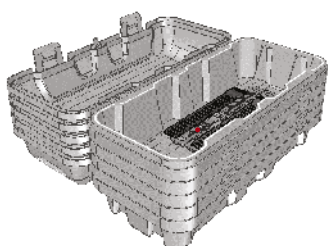

all dimensions are in mm

SHELLY SOLID RED

FIRE EXTINGUISHER BOX



UV stabilized polypropylene copolymer

Colour: red (UV stabilized)



Suitable for 6kg fire extinguishers.

Solid red finish with separate self-adhesive resin extinguisher label for external application.

Water and dust resistance provided by integrated sealing and coupling features in lid.

Quick release latches ensure prompt opening of the lid in case of an emergency.

The unique fire extinguisher retention system mounts directly to the vehicle whilst the fire extinguisher outer case becomes a non-structural protective element for the extinguisher itself.

Adjustable and extensible high-resistance elastomer retention straps.

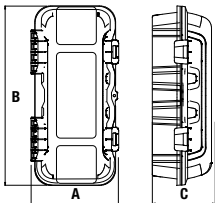

Code	extinguisher	extinguisher Ø min-max	A	B	C	kg	std packaging
49 61 46 010	6kg	150-170	305	627	220	1,9	18/126 pcs

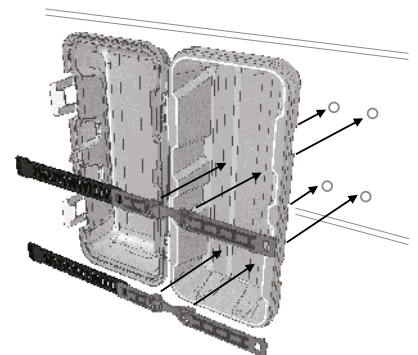
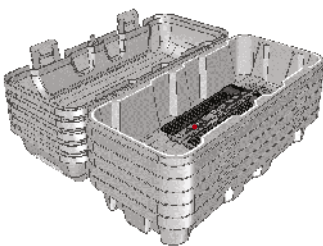

all dimensions are in mm

FITEASY

FIRE EXTINGUISHER BOX



UV stabilized polypropylene copolymer

Colour: red and black (UV stabilized)

Ultimate quality - Unparalleled style

3 sizes: 6kg, 6/9kg and 9/12kg

Ergonomic closures with double action lever against accidental opening

Pre assembled exclusive Rex internal adjustable retention system included

Pre arranged mounting hole pattern

Can be used as side protection device according to regulation ECE 73R01
further details under download section www.lagoaccessori.it

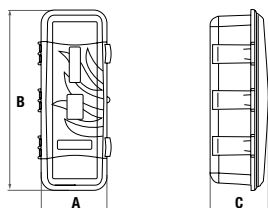

Code	extinguisher	extinguisher Ø min-max	A	B	C	kg	std packaging
49 66 23 010	6kg	150-190	300	610	255	4,2	42 pcs
49 66 23 013	6/9kg	150-190	300	700	255	4,7	42 pcs
49 66 23 015	9/12kg	150-190	300	775	255	5	32 pcs



all dimensions are in mm

RELEASE

FIRE EXTINGUISHER BOX WITH REMOVABLE LID



UV stabilized polyethylene

Colour: red and black, black (UV stabilized)

- Single action quick operation
- 2 sizes: 6kg and 9/12kg
- Security clip against accidental opening
- Pre-assembled exclusive Rex internal adjustable retention system included

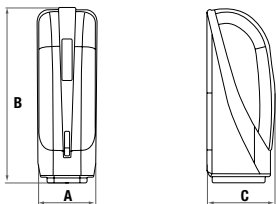

Code	colour	extinguisher	extinguisher Ø min-max	A	B	C	kg	std packaging
49 56 18 010	Black-red	6kg	150-190	260	635	275	3,85	48 pcs
49 56 18 015	Black-red	9/12kg	150-190	255	765	300	5,2	28 pcs
49 50 18 010	Black-black	6kg	150-190	260	635	275	3,85	48 pcs
49 50 18 015	Black-black	9/12kg	150-190	255	765	300	5,2	28 pcs



all dimensions are in mm

FOLPY

TOP LOAD FIRE EXTINGUISHER BOX



Uv stabilized polyethylene

Colour: red and black (UV stabilized)



Usability & Style

Suitable for 6 kg fire extinguishers

Quick and ergonomic opening with twisting lid and safety clip for double safety against accidental opening

Internal retention spring element

Supplied hardware kit to fix Folpy to the supports

The use of dedicated LAGO mounting bracket kit is suggested to ensure optimum product performance

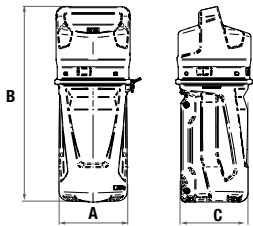

Folpy

Code	extinguisher	extinguisher Ø min-max	A	B	C	kg	std packaging
49 56 40 010	6kg	150 - 165	282	636	250	2,0	36 pcs

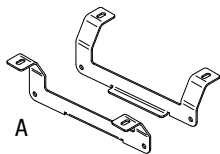

FOLPY EASY BRACKET einfache horizontale-Montage

Code	description	fig.	kg	std packaging
31 16 63 001	S 235 JR (Fe360 BFN) - Black polyester powder coating	A	1	1 pair



FOLPY UNIVERSAL BRACKET

Smart and versatile. One product to cover all needs

Code	description	kg	std packaging
31 16 63 000	S 235 JR (Fe360 BFN) - Black polyester powder coating	3	1 pair

CHASSIS

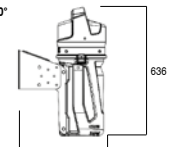
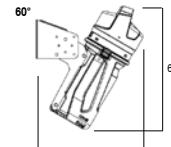
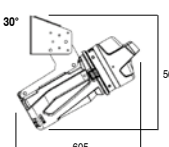
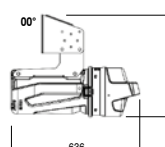

PLATFORM

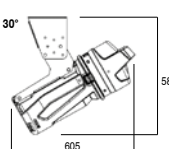
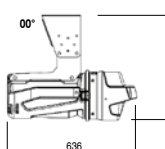

all dimensions are in mm

SLYKÒN

SLIDE ACTION EXTINGUISHER BOX



GF reinforced polypropylene

Colour: red and black (UV stabilized)

Easy and fast access to the extinguisher thanks to innovative slide-tilt opening

Supplied only with dedicated mounting bracket kit, horizontal or angled version - Exclusive retention system

Can be used as side protection device according to regulation ECE 73R01

further details under download section www.lagoaccessori.it

SLYKÒN

Code	extinguisher	A	B	C	extinguisher Ø min-max	kg	fig.	std packaging
49 66 25 013	6/9/12kg	322	311	729	150-190	3,5	A	42 pcs

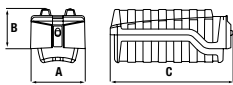

A SLYKÒN

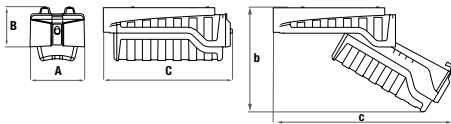

B Horizontal fitting bracket

Horizontal fitting bracket kit

Code	extinguisher	A	B	C	extinguisher Ø min-max	b	c	kg	fig.	std packaging
31 16 61 101	6/9/12kg	320	315	766	150-190	571	1013	11,8	B	24 pcs

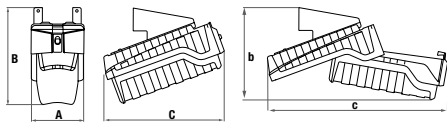

C Angled fitting bracket

Angled fitting bracket kit

Code	extinguisher	A	B	C	extinguisher Ø min-max	b	c	kg	fig.	std packaging
31 16 61 102	6/9/12kg	320	585	723	150-190	560	1085	7,5	C	24 pcs

GRABBY

ADJUSTABLE FIRE EXTINGUISHER VERTICAL CRADLE



Painted red steel S235JR - Stainless steel AISI 304 2B

Adjustable fire extinguisher cradle

Rex extinguisher retention kit included

Recommended for static application only

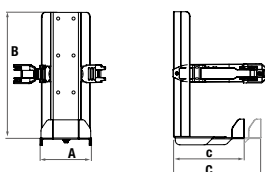

Code	finishing	extinguisher	A	B	c-C	extinguisher Ø min-max	kg	std packaging
49 17 35 015	Red epoxy coating	6/9/12kg	167	432	170/210	150-190	3,4	2 pcs
49 30 35 015	Stainless steel	6/9/12kg	167	432	170/210	150-190	3,4	2 pcs

all dimensions are in mm

SPARE PARTS AND ACCESSORIES

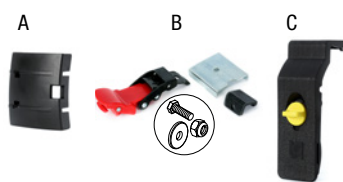

Code	description	A	B	C	std packaging
05 09 04 037	A - Fiteasy - Nylon lever latch				bulk
07 11 04 002	B - Releasy - Locking clip for 6 and 9/12kg model				bulk
07 50 04 001	C - Slykòn - Handle sub assembly				bulk
32 11 20 001	D - Releasy - Galvanized steel mounting bracket	153	503	170	bulk

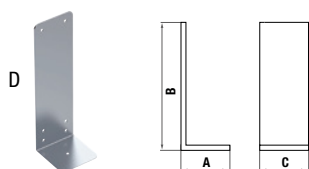

Code	description	std packaging
50 50 15 010	Releasy - Lid for 6kg model - black	2 pcs
50 51 15 010	Releasy - Lid for 6kg model - red	2 pcs
50 50 15 015	Releasy - Lid for 12kg model - black	2 pcs
50 51 15 015	Releasy - Lid for 12kg model - red	2 pcs

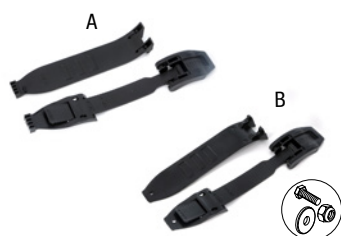

Code	description	std packaging
07 60 04 002	A - Fiteasy Rex retention kit	bulk
07 60 04 003	B - Releasy and Grabby Rex retention kit	bulk

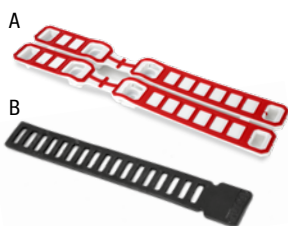

Code	description	std packaging
05 09 04 040	A - Shelly retention kit	1 pair
05 07 02 049	B - Shelly rubber fastener	12 pcs



Code	description	std packaging
50 51 40 010	A - Folpy Lid and safety clip	bulk
05 05 02 034	B - Folpy Safety clip	bulk
05 07 02 048	C - Folpy O-ring	bulk

all dimensions are in mm

64

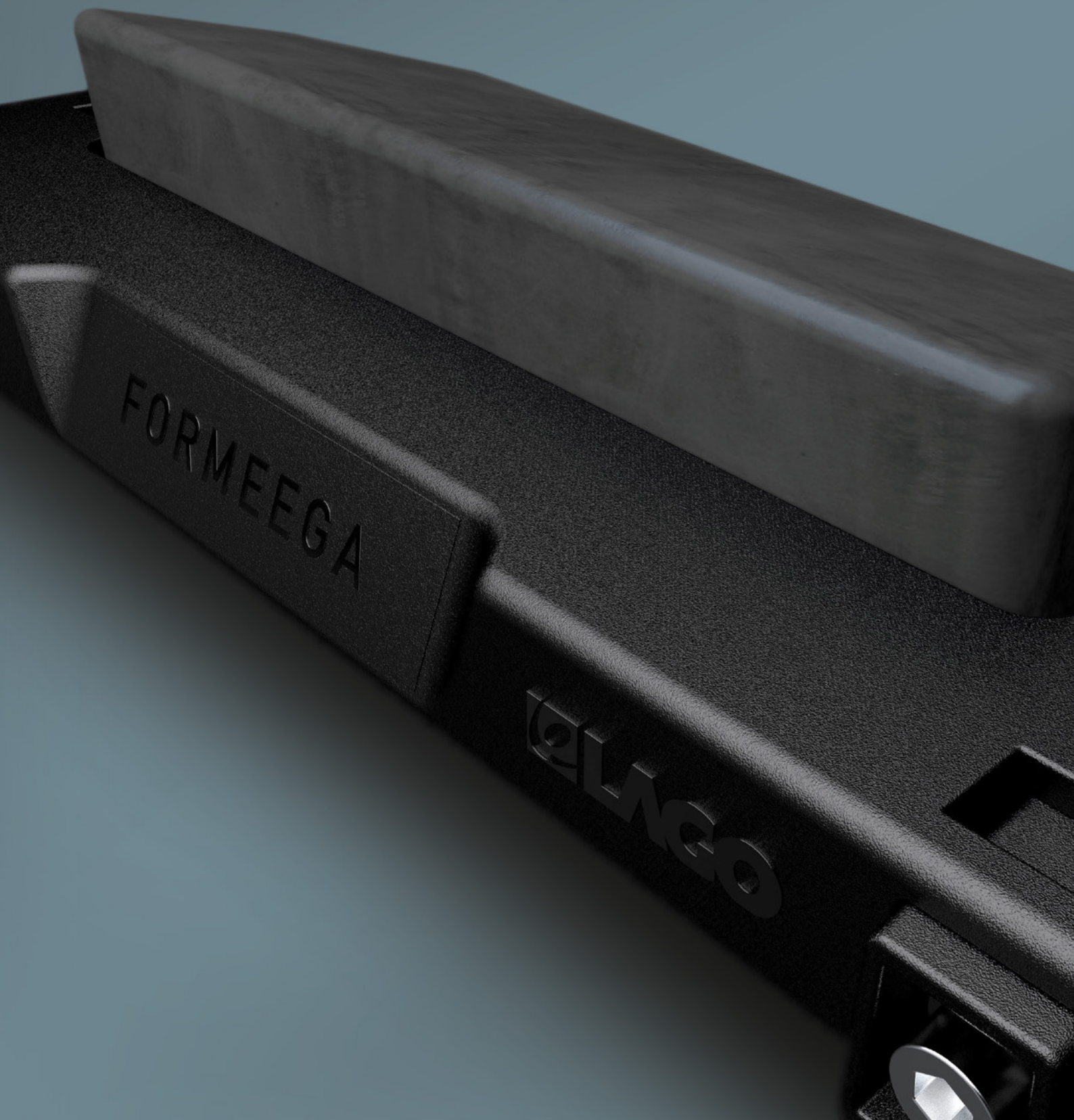

HOLDYX - ROLLYX
FORMEEGA
PORTTER UNIVERSAL
HOSE PROTEX

SPECIAL CARRIERS

HOLDYX & ROLLYX

DOCUMENT HOLDERS

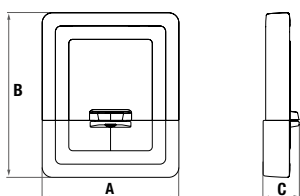

Holdyx

UV stabilized polyethylene

Colour: grey (UV stabilized)

Trailer document holder - Sliding, removeable lid with bungee chord

Code	A	B	C	kg	std packaging
53 50 12 001	270	325	71	0,8	26 pcs

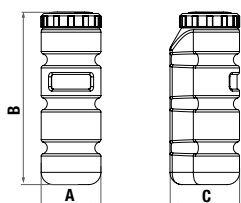

Rollyx

UV stabilized polyethylene

Colour: grey and black (UV stabilized)

Provided with integrated threaded bushings
Watertight threaded cap with bungee chord
Ø 90mm opening

Code	A	B	C	kg	std packaging
53 57 15 001	120	340	140	1	21 pcs

all dimensions are in mm

FORMEEGA

TIPPER SUPPORTING PAD

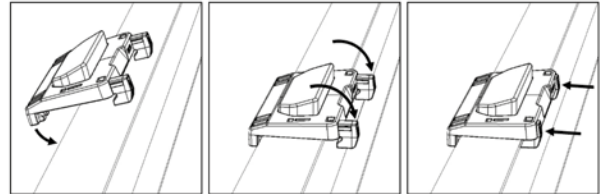
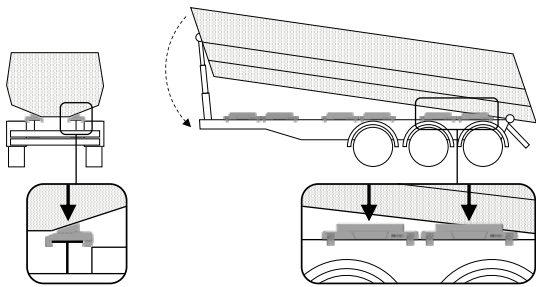
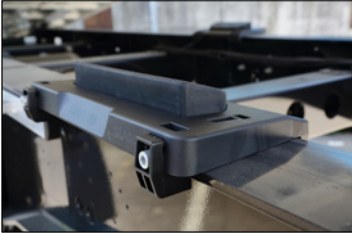

Uv stabilized PA6 + Rubber

Colour: black

Supporting pad for tipping trailers

The adjustable fixing system makes the pad adaptable to different main beam dimension:
125-160 mm width, 7-12 mm thickness

The height of the support can be adjusted thanks to dedicated spacers

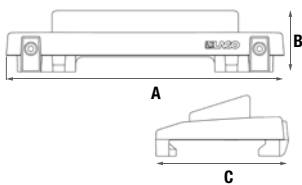

Formeega

Code	description	A	B	C (min-max)	kg	std packaging
40 05 25 001	With sloping pad	420	90	190-230	3	6 pcs
40 05 25 002	With flat pad	420	64	190-230	2,5	6 pcs

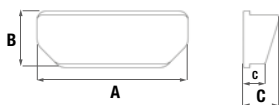

Formeega Pad

Code	description	A	B	c-C	kg	std packaging
40 07 24 001	Sloping pad	280	104	42-67	2	bulk
40 07 24 003	Flat pad	280	104	64	1,5	bulk

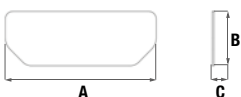

Formeega Spacer

Code	A	B	C	kg	std packaging
40 07 24 002	280	100	4	0,15	24 pcs

all dimensions are in mm

PORTTER UNIVERSAL

BROOM, SHOVEL AND LADDER HOLDER

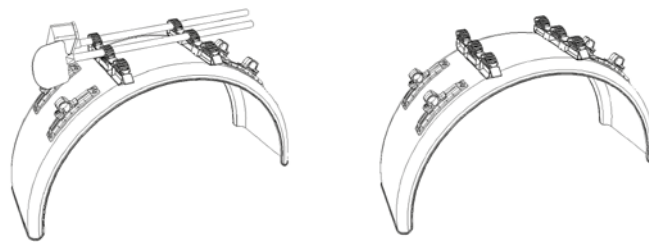

PA6 GF + Rubber

Colour: black

Lighter, Faster, Better
Simple and fast assembly
Substantial weight reduction
Necessary hardware for fastening to mudguard included
Extra corrosion resistant

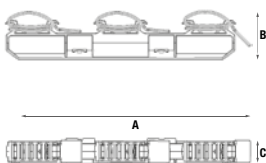

Portter Universal

Code	A	B	C	kg	std packaging
72 60 40 001*	425	90	45	0,5	8 pcs

*3 rubber fasteners (05 07 02 049) included

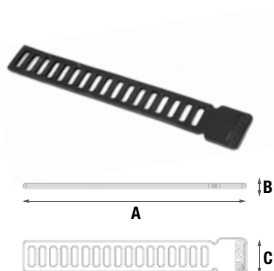

Spare parts - Rubber Portter fasteners

Code	A	B	C	kg	std packaging
05 07 02 049	290	5	45	0,05	12 pcs

all dimensions are in mm

HOSE PROTEX

HOSE HOLDERS



UV stabilized polypropylene copolymer

Colour: black (UV stabilized) and stainless steel

Door Supplied with locking system and key - Polypropylene
 End cap Ø 160 or 200mm - Polyethylene
 Tube Ø 160 or 200mm - 4 standard lengths - Different sizes upon request

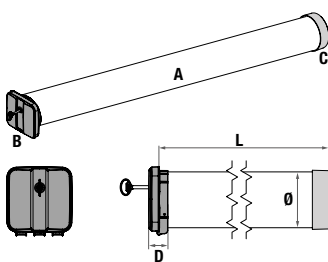

A+B+C - Supplied installed

Code	Ø	L	thickness	D	std packaging
69 60 10 010	160	3000	5	30	20 pcs
69 60 10 015	160	4000	5	30	20 pcs
69 60 10 020	160	5000	5	30	20 pcs
69 60 10 025	160	6000	5	30	20 pcs
69 60 15 010	200	3000	7	30	20 pcs
69 60 15 015	200	4000	7	30	20 pcs
69 60 15 020	200	5000	7	30	20 pcs
69 60 15 025	200	6000	7	30	20 pcs



Code	description	Ø	fig.	std packaging
59 60 20 030	Polypropylene door	160	B	bulk
59 60 20 035	Polypropylene door	200	B	bulk
05 60 02 001	Polypropylene end cap	160	C	bulk
05 60 02 002	Polypropylene end cap	200	C	bulk

all dimensions are in mm

70



SOPÉO
MINI SOPÉO 13-14
LAGOMAX
SEENA 2.0
SIDE BASIC SET

PROTECTION DEVICES

SOPÉO

WHEEL CHOCK



Polypropylene

Colour: yellow (UV stabilized)

Practical quick release mechanism

Certified in accordance with DIN 76051-E53 and DIN 76051-E46

Integrated handle in accordance with DIN 76051-E53 and DIN 76051-E53

Version with integrated blade

Solid and lightweight reticular structure

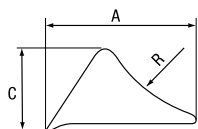

Code	description	A	B	C	R	kg	std packaging
48 63 22 001	Wheel chock Sopéo E46	380	160	190	460	1	216 pcs
48 63 23 001	Wheel chock Sopéo E46 with blade	380	160	190	460	1,1	216 pcs
48 63 12 001	Wheel chock Sopéo E53	470	200	230	560	1,4	130 pcs
48 63 13 001	Wheel chock Sopéo E53 with blade	470	200	230	560	1,5	130 pcs

ACCESSORIES

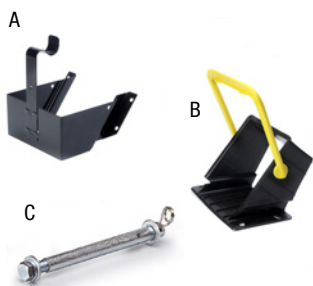

Code	description	fig.	kg	std packaging
32 16 58 001	Black painted metallic wheel chock E46 holder	A	1	138 pcs
32 16 59 001	Black painted metallic wheel chock E53 holder	A	1,4	80 pcs
32 60 61 001	Plastic wheel chock E53 holder	B	1	10 pcs
32 11 60 001	Galvanized tubular support wheel chock holder	C	0,6	40 pcs

all dimensions are in mm

MINI SOPÉO 13-14

WHEEL CHOCK



Polypropylene

Colour: black (UV stabilized)

Practical and smart
Ideal wheel chock solution for light trailers
Supplied with mounting support, suitable for 13" and 14" wheels
Tested at 1600 kg

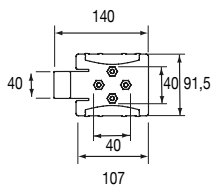
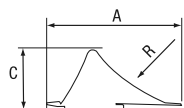

Code	description	A	B	C	R	kg	std packaging
31 60 29 100	Wheel chock Mini Sopéo 13-14	247	90	109,6	270	0,27	60/1200 pcs



all dimensions are in mm

LAGOMAX & LAGOMAXPRO

REAR UNDERRUN PROTECTORS



LAGOMAX REAR UNDERRUN PROTECTORS

Steel - Thickness 1,8-2-3mm

Colour: grey - RAL 9006 Epoxy powder coating - UV stabilized polyethylene end caps

Colour: white - RAL9010 Epoxy powder coating - UV Stabilized polyethylene end caps

Different sizes and colours available upon request - Minimum order quantity requirement

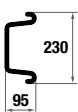

Code	length	height	thickness	colour	kg	std packaging
33 18 21 010	1800	230	1,8	grey	10,8	multiple of 3 or 4
33 18 21 030	1900	230	1,8	grey	11,4	multiple of 3 or 4
33 18 21 050	2000	230	1,8	grey	12	multiple of 3 or 4
33 18 21 070	2100	230	1,8	grey	12,5	multiple of 3 or 4
33 18 21 090	2200	230	1,8	grey	13	multiple of 3 or 4
33 18 21 110	2300	230	1,8	grey	13,7	multiple of 3 or 4
33 18 21 130	2400	230	1,8	grey	14,3	multiple of 3 or 4
33 16 01 007	2300	230	1,8	white	13,7	multiple of 3 or 4
33 16 01 010	2400	230	1,8	white	14,3	multiple of 3 or 4
34 18 21 110	2300	230	3	grey	22,6	multiple of 3 or 4
34 18 21 130	2400	230	3	grey	23,6	multiple of 3 or 4



35 18 21 110	2300	430	2	grey	20,7	multiple of 2
35 18 21 130	2400	430	2	grey	21,6	multiple of 2
35 16 01 002	2300	430	2	white	20,7	multiple of 2
35 16 01 001	2400	430	2	white	21,6	multiple of 2

LAGOMAX PRO REAR UNDERRUN PROTECTORS

Machine turned finish stainless steel AISI 304B - Thickness 2mm

Aluminium - Thickness 5mm

Different sizes and colours available upon request - Minimum order quantity requirement

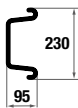

Machine turned finish stainless steel AISI 304B

Code	length	height	thickness	end caps	kg	std packaging
33 32 21 110	2300	230	2	polyethylene	15,2	multiple of 3 or 4
33 32 21 130	2400	230	2	polyethylene	15,8	multiple of 3 or 4
33 32 24 110	2300	230	2	m.t. finish stainless steel	15,2	multiple of 3 or 4
33 32 24 130	2400	230	2	m.t. finish stainless steel	15,8	multiple of 3 or 4

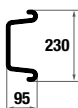

Aluminium

34 45 21 110	2300	230	5	polyethylene	13,1	multiple of 3 or 4
34 45 21 130	2400	230	5	polyethylene	13,6	multiple of 3 or 4



Machine turned finish stainless steel AISI 304B

35 32 21 110	2300	430	2	polyethylene	22,9	multiple of 2
35 32 21 130	2400	430	2	polyethylene	23,9	multiple of 2
35 32 24 110	2300	430	2	m.t. finish stainless steel	23	multiple of 2
35 32 24 130	2400	430	2	m.t. finish stainless steel	24	multiple of 2
35 32 25 110	2300	430	2	skewed-m.t. finish. st. steel	22,9	multiple of 2
35 32 25 130	2400	430	2	skewed-m.t. finish. st. steel	23,9	multiple of 2



Code	description	kg	std packaging
39 50 10 001	End caps	0,11	100 pair

all dimensions are in mm

SEENA 2.0

TYPE APPROVED ALUMINIUM UNDERRUN PROTECTION SYSTEM



SEENA 2.0 ACCESSORY PROFILE



SEENA 2.0

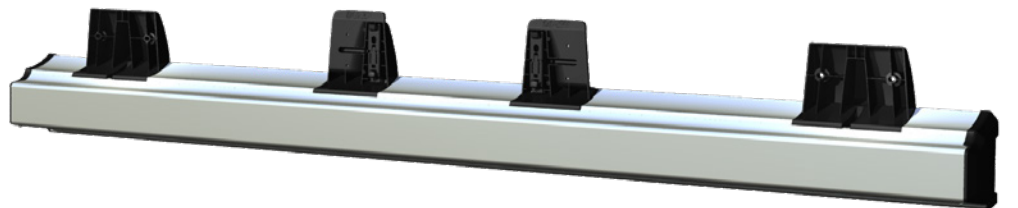

SEENA 2.0 PLUS

Anodized aluminium 6082 T6 profile and cable housing cover - GF Reinforced nylon end caps
Profile/bracket fastening hardware included

Anodized aluminium
3 available versions
4 standard lengths, other lengths upon request
Compatible with most popular lighting brands
Mounting supports and reinforcement brackets
Customisable rear mudflaps availability
Laser customisation upon request

Type-approved: Seena aluminium rear underrun protection profile is type-approved according to Regulation ECE R.58-03

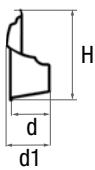

SEENA 2.0 PLUS

Fully integrated rear underrun protection device – number plate and light holders included

Code	L	H	d/d1	kg	std packaging
37 49 37 070	2100	339	154/168	20,1	1 pc
37 49 37 090	2200	339	154/168	21	1 pc
37 49 37 110	2300	339	154/168	21,85	1 pc
37 49 37 130	2400	339	154/168	22,7	1 pc



SEENA 2.0

Rear underrun protection

Code	L	H	d	kg	std packaging
37 49 35 070	2100	195	154	18,7	1 pc
37 49 35 090	2200	195	154	19,6	1 pc
37 49 35 110	2300	195	154	20,4	1 pc
37 49 35 130	2400	195	154	21,3	1 pc

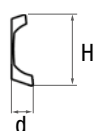

SEENA 2.0 ACCESSORY PROFILE

Lighting and number plate support

Code	L	H	d	kg	std packaging
37 49 36 070	2100	253	78	7,1	1 pc
37 49 36 090	2200	253	78	7,4	1 pc
37 49 36 110	2300	253	78	7,7	1 pc
37 49 36 130	2400	253	78	8	1 pc

all dimensions are in mm

SEENA 2.0 SUPPORTS & REINFORCEMENTS

CONFIGURE SEENA 2.0

SEENA 2.0 rear underrun device is type approved according to the ECE R.58-03 regulation when installed using the supporting elements and brackets which are indicated in the Homologation document, available for download in the dedicated section of our website www.lagoaccessori.net

Precise combinations of mounts and brackets are required for compliance based on the variables in the vehicle. The following table can guide you in choosing the right elements for your vehicle.

By following these steps you will be led to a required configuration

- S** Choose **SUPPORT 2.0 bumper** type
- L** Choose **SEENA length**
- d** Choose **distance range between SUPPORTS**
- R**= Intersect **L** & **d** in the following table to find the suitable **REINFORCEMENT BRACKETS** and their positioning (internal and/or external)

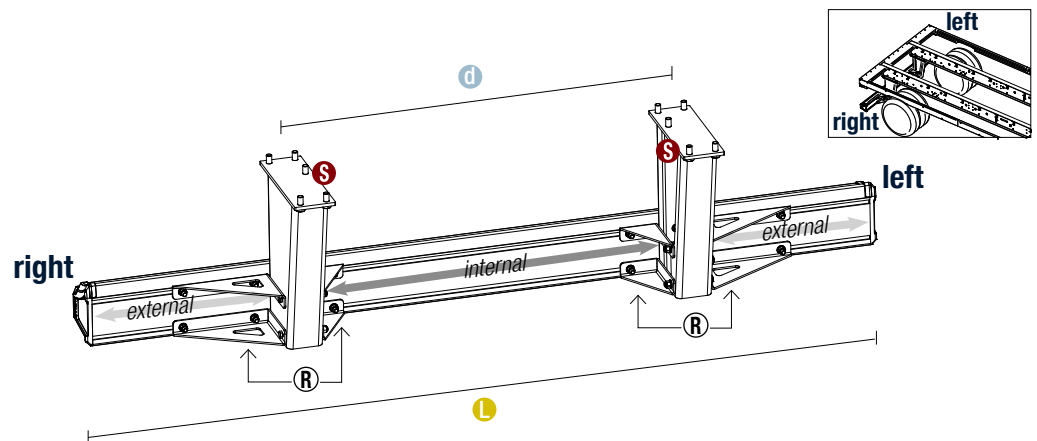

S SUPPORT	L SEENA length	position	d distance between SUPPORTS		
			850-1199	1200-1350	1351-1450
S1 31 10 46 101	2100	internal	-	-	-
		external	R1 31 20 46 202	R2 31 20 46 203	R2 31 20 46 203
	2200	internal	-	-	-
		external	R1 31 20 46 202	R2 31 20 46 203	R2 31 20 46 203
	2300	internal	-	-	-
		external	R1 31 20 46 202	R2 31 20 46 203	R2 31 20 46 203
	2400	internal	-	-	-
		external	R1 31 20 46 202	R2 31 20 46 203	R2 31 20 46 203

S SUPPORT	L SEENA length	position	d distance between SUPPORTS		
			850-1199	1200-1350	1351-1450
S2 31 10 46 102	2100	internal	R2 31 20 46 201	-	R1 31 20 46 201
		external	R1 31 20 46 201	R2 31 20 46 203	R2 31 20 46 201
	2200	internal	R2 31 20 46 201	-	R1 31 20 46 201
		external	R1 31 20 46 201	R2 31 20 46 203	R2 31 20 46 201
	2300	internal	R2 31 20 46 201	-	R1 31 20 46 201
		external	R1 31 20 46 201	R2 31 20 46 203	R2 31 20 46 201
	2400	internal	R2 31 20 46 201	-	R1 31 20 46 201
		external	R1 31 20 46 201	R2 31 20 46 203	R2 31 20 46 201

S SUPPORT	L SEENA length	position	d distance between SUPPORTS		
			850-1199	1200-1350	1351-1450
S3 31 20 46 103	2100	internal	R2 31 20 46 201	-	R1 31 20 46 201
		external	R1 31 20 46 201	R2 31 20 46 203	R2 31 20 46 201
	2200	internal	R2 31 20 46 201	-	R1 31 20 46 201
		external	R1 31 20 46 201	R2 31 20 46 203	R2 31 20 46 201
	2300	internal	R2 31 20 46 201	-	R1 31 20 46 201
		external	R1 31 20 46 201	R2 31 20 46 203	R2 31 20 46 201
	2400	internal	R2 31 20 46 201	-	R1 31 20 46 201
		external	R1 31 20 46 201	R2 31 20 46 203	R2 31 20 46 201

all dimensions are in mm

SEENA 2.0 SUPPORTS & REINFORCEMENTS

SUPPORTS

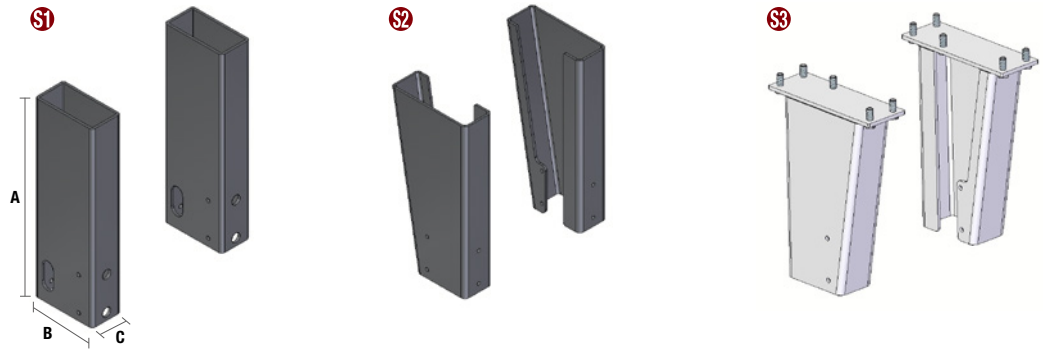

Code	description	fig.	A	B	C	sp	mat/finishing	kg	std packaging
31 10 46 101	Weldable	S1	600	200	100	8	Uncoated steel	40,6	bulk
31 10 46 102	Weldable	S2	600	300	110	8	Uncoated steel	39,8	bulk
31 20 46 103	Bolttable	S3	510	370	126	8	Black epoxy coating + Cataphoresis	41	bulk

REINFORCEMENT BRACKETS

R1 external configuration

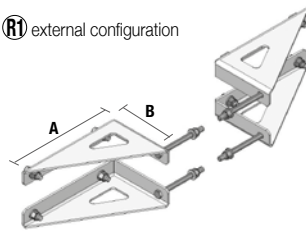

internal configuration

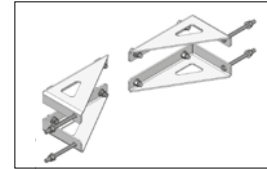

R2 external configuration

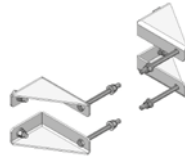

internal configuration

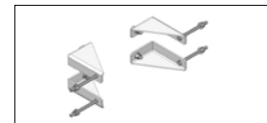

R1
R2 configuration

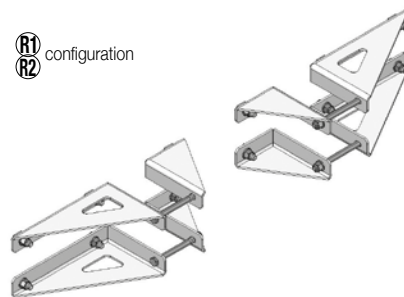

R2
R1 configuration

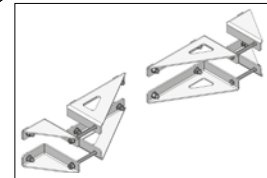

Code	description	fig.	A	B	C	sp	mat/finishing	kg	std packaging
31 20 46 202	Reinforcement bracket	R1	297,5	180		5	Black epoxy coating + Cataphoresis	8	bulk
31 20 46 203	Reinforcement bracket	R2	117,5	180		5	Black epoxy coating + Cataphoresis	4,5	bulk
31 20 46 201	Reinforcement bracket	R1 or R2					Black epoxy coating + Cataphoresis	11,8	bulk

all dimensions are in mm

SEENA 2.0 ACCESSORIES AND SPARE PARTS

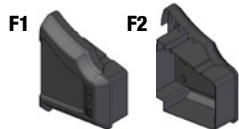
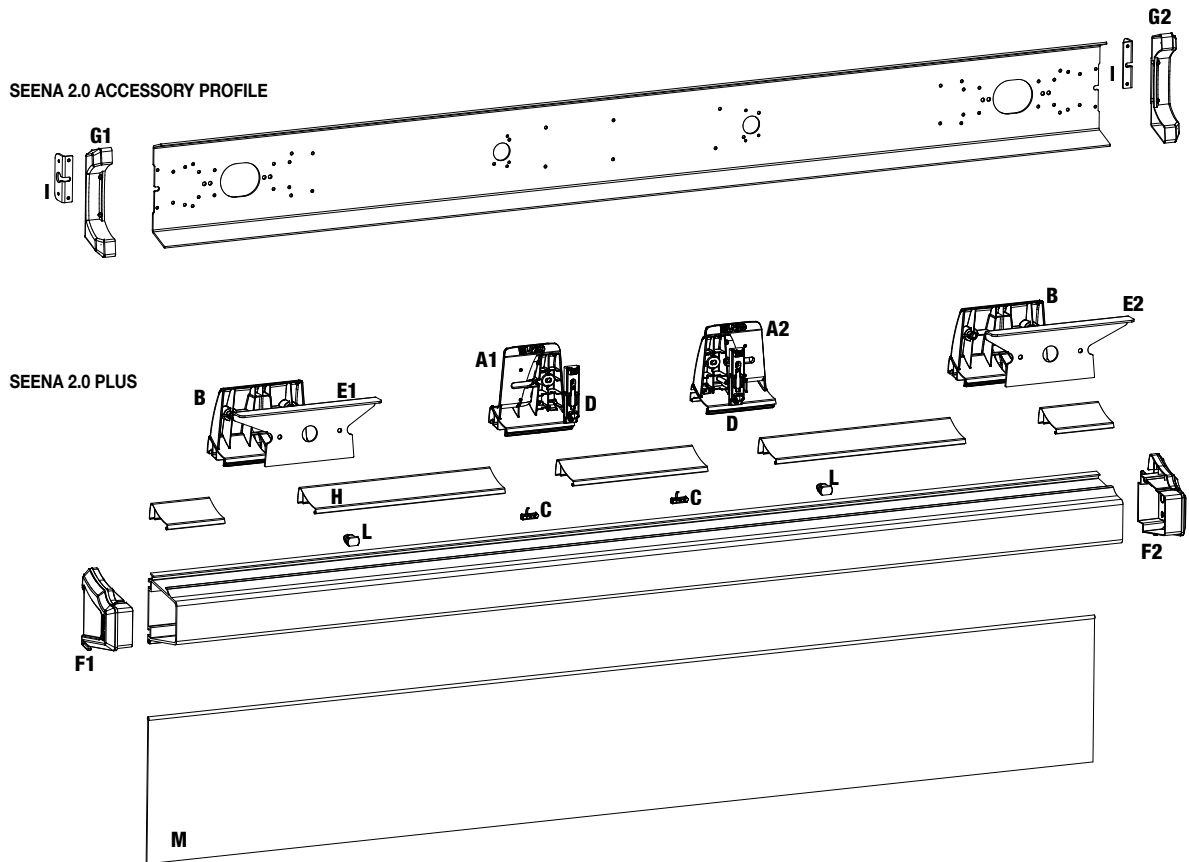

Code	description	kg	std packaging
39 05 15 001	End cap for SEENA 2.0 and SEENA 2.0 plus (LEFT)	0,2	1 pc
39 05 15 002	End cap for SEENA 2.0 and SEENA 2.0 plus (RIGHT)	0,2	1 pc



39 05 15 003	End Cap for SEENA 2.0 Accessory profile (LEFT)	0,1	1 pc
39 05 15 004	End Cap for SEENA 2.0 Accessory profile (RIGHT)	0,1	1 pc

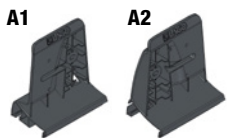

73 05 13 002	Number plate holder module (RIGHT)	0,36	1 pc
73 05 13 001	Number plate holder module (LEFT)	0,36	1 pc



70 05 35 001	Headlight holder stand	0,5	1 pc
--------------	------------------------	-----	------



CIAPEEN - Spring loaded number plate holder - Can be used for Seena rear underrun protection or others			
Code	description	kg	std packaging
73 60 11 061	Ciapeen - Acetalic resin spring loaded number plate holders	0,03	24 pairs

all dimensions are in mm

SEENA 2.0 ACCESSORIES AND SPARE PARTS

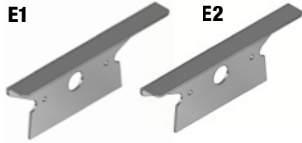

Code	description	kg	std packaging
70 49 35 001	Aluminium tail lamp protector (LEFT)	0,5	1 pc
70 49 35 002	Aluminium tail lamp protector (RIGHT)	0,5	1 pc

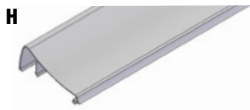

		L		
47 45 46 240	Cable duct cover	2400	1,5	1 pc



71 09 01 001	Cable gland for SEENA 2.0	0,01	1 pc
--------------	---------------------------	------	------



70 49 35 003	Aluminium support for external lighting	0,07	1 pc
--------------	---	------	------



08 11 01 080	SEENA 2.0 mounting bolt 2.0 M12x35 CL.10.9	0,06	1 pc
--------------	--	------	------

SEENA 2.0 REAR MUDFLAP

PVC thickness 4mm

Colour: black

Personalized versions are available upon request. One or more color silk screen printing.

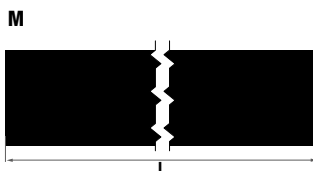

Code	description	L	thickness	kg	std packaging
13 70 74 005	Mudflap for SEENA 2.0 profile	2100	4	3,25	5 pcs
13 70 74 004	Mudflap for SEENA 2.0 profile	2200	4	3,4	5 pcs
13 70 74 001	Mudflap for SEENA 2.0 profile	2300	4	3,55	5 pcs
13 70 74 002	Mudflap for SEENA 2.0 profile	2400	4	3,7	5 pcs



MUDFLAP CUSTOMISATION

Silk screen printing
One or more colours upon request

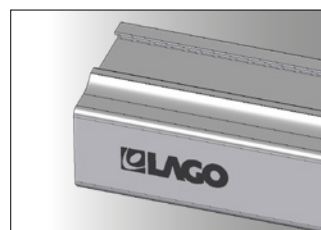

PROFILE CUSTOMIZATION

Laser printing

all dimensions are in mm

LATERAL UNDERRUN PROTECTION DEVICES



SIDE BASIC SET

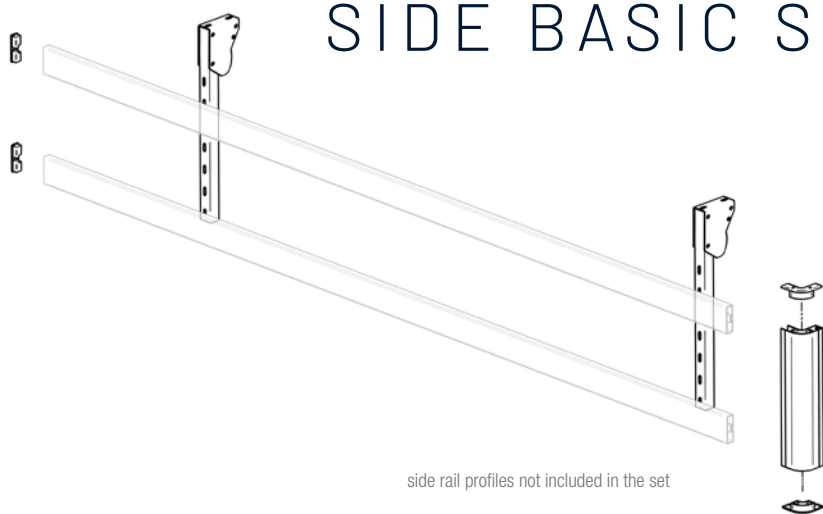

side rail profiles not included in the set

Code 31 11 40 003 is a basic set suitable for equipment of one side of the trailer

Code	description	Qty	kg	std packaging
31 11 40 003	Side Basic set	1	7,8	1 box 800X160X130 mm*
Set composition:				
31 11 40 001	Pair of spring loaded adjustable VIP brackets	1		
47 45 41 005	Anodized aluminium 6060 T6 corner element	1		
05 60 02 004	Corner element end caps 100x100	2		
05 60 02 003	Side rail profile end caps 100x30	2		

*side rail profiles not included in the set

VIP

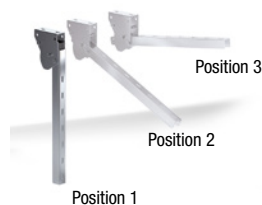

Galvanized metal Steel S235JR

Vip side protection adjustable supports

Code	description	kg	std packaging
31 11 40 001	Vip	5,2	10 pairs

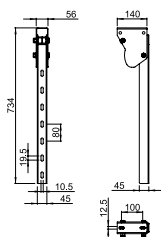

all dimensions are in mm

LATERAL UNDERRUN PROTECTION DEVICES

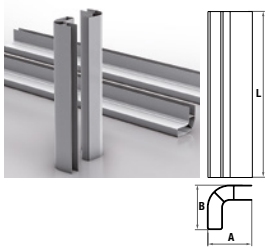

Anodized aluminium 6060 T6

Code	description	A	B	L	kg	std packaging
47 45 41 005	Anodized aluminium 6060 T6 corner element	100	100	500	1,1	bulk

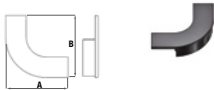

Nylon TA6

Code	description	A	B	kg	std packaging
05 60 02 004	Corner element end cap 100x100	100	100	0,2	bulk

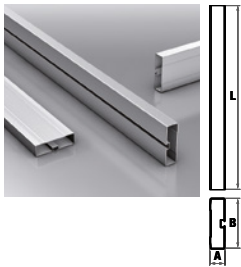

Anodized aluminium 6060 T6

Code	description	A	B	L	kg	std packaging
47 45 40 027	Side rail profile	30	100	3250	3,9	bulk
47 45 40 045	Side rail profile	30	100	6500	7,8	bulk
47 45 40 060	Side rail profile	30	100	7500	9	bulk



Rubber

Code	description	A	B	kg	std packaging
05 60 02 003	Side rail profile end cap	30	100	0,2	bulk

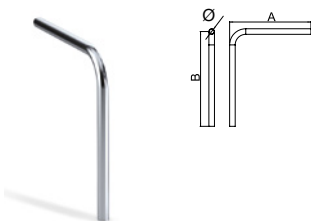

Code	description	A	B	Ø	thickness	kg	std packaging
42 11 10 001	90° Fix bent tube	805	805	54	2	4,1	bulk

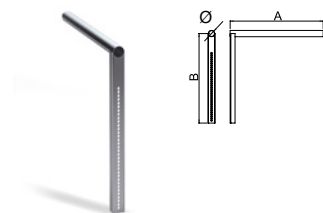

Code	description	A	B	Ø	thickness	kg	std packaging
42 11 10 003	90° fix tube with installation slots	800	800	54	2	4,5	bulk

Check which specific product configuration is type-approved according to regulation ECE 73R01 under download section www.lagoaccessori.it

all dimensions are in mm

PACKAGING DETAILS TOOL BOXES

POLYBAG INDIVIDUAL PACKAGING - WOODEN PALLET

PLASTIC PALLET AVAILABILITY - PALLET FILM WRAP

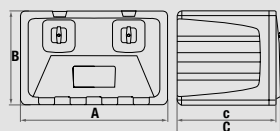
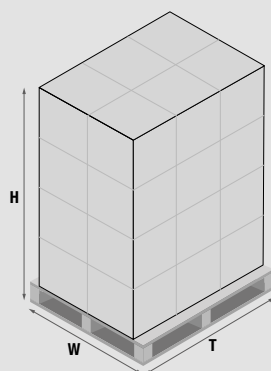

BLACK DOG

Code	A	B	C	std packaging	W	T	H	gross weight (kg)*	volume (m³)
44 50 55 115	400	350	420	30 pcs	800	1200	2200	270	2,11
44 50 55 103	500	350	420	32 pcs	850	1400	2150	212	2,56
44 50 55 083	600	450	490	24 pcs	1000	1350	2550	234	3,44
44 50 55 081	600	450	670	16 pcs	900	1350	2550	180	3,09
44 50 55 084	600	550	670	16 pcs	1100	1350	2550	197	3,78
44 50 55 060	700	450	490	18 pcs	1000	1350	2250	202	3,04
44 50 55 053	700	450	670	12 pcs	900	1350	2250	157	2,73
44 50 55 040	750	360	350	27 pcs	1100	1100	2400	224	2,9
44 50 55 033	800	450	490	18 pcs	1000	1350	2550	220	3,44
44 50 55 020	1000	500	490	12 pcs	1000	1500	2150	193	3,22
44 50 55 017	1000	500	670	8 pcs	1000	1360	2150	157	2,92

* Wooden pallet packaging

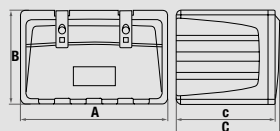

VERTIGO

Code	A	B	C	std packaging	W	T	H	gross weight (kg)*	volume (m³)
44 50 25 115	400	350	420	30 pcs	800	1200	2200	270	2,11
44 50 25 103	500	350	420	32 pcs	850	1400	2150	212	2,56
44 50 25 083	600	450	490	24 pcs	1000	1350	2550	234	3,44
44 50 25 081	600	450	670	16 pcs	900	1350	2550	180	3,09
44 50 25 084	600	550	670	16 pcs	1100	1350	2550	197	3,78
44 50 25 060	700	450	490	18 pcs	1000	1350	2250	202	3,04
44 50 25 053	700	450	670	12 pcs	900	1350	2250	157	2,73
44 50 25 040	750	360	350	27 pcs	1100	1100	2400	224	2,9
44 50 25 033	800	450	490	18 pcs	1000	1350	2550	220	3,44
44 50 25 020	1000	500	490	12 pcs	1000	1500	2150	193	3,22
44 50 25 017	1000	500	670	8 pcs	1000	1360	2150	157	2,92

* Wooden pallet packaging

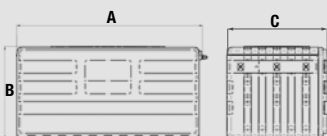

KOMPOS-IT

Code	A	B	C	std packaging	W	T	H	gross weight (kg)*	volume (m³)
80 60 62 115.0100	1200	600	650	12 pcs	1200	1200	2000	310	2,8
80 60 62 095.0100	1000	600	650	12 pcs	1200	1200	2000	250	2,8

* Wooden pallet packaging, cardboard box individual packaging

all dimensions are in mm

PACKAGING DETAILS TOOL BOXES

POLYBAG INDIVIDUAL PACKAGING - WOODEN PALLET

PLASTIC PALLET AVAILABILITY - PALLET FILM WRAP

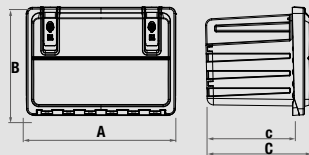
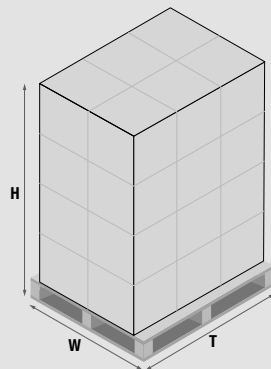

MOTHER TRUCKER assembled version

Code	A	B	C	std packaging	W	T	H	gross weight (kg)*	volume (m ³)
44 60 62 116	400	350	375	40 pcs	800	1300	2200	145	2,76
44 60 62 100	500	350	455	40 pcs	1000	1350	2400	165	2,60
44 60 62 090	600	400	475	30 pcs	1200	1300	2450	184	3,17
44 60 62 045	690	500	480	20 pcs	1000	1350	2450	149	3,38
44 60 62 043	750	350	300	28 pcs	800	1350	2400	163	2,50
44 60 62 042	750	350	450	20 pcs	800	1350	2400	223	2,50
44 60 62 030	800	500	475	18 pcs	1000	1400	2450	161	3,50
44 60 62 020	1000	500	480	15 pcs	1000	1450	2450	159	3,57

MOTHER TRUCKER dis-assembled version

Code	A	B	C	std packaging	W	T	H	gross weight (kg)*	volume (m ³)
44 60 63 116	400	350	375	50 pcs	800	1200	2150	178	2,35
44 60 63 100	500	350	455	64 pcs	1000	1350	2500	257	3,38
44 60 63 090	600	400	475	36 pcs	800	1200	2520	219	2,42
44 60 63 045	690	500	480	30 pcs	1000	1350	2500	217	2,97
44 60 63 043	750	350	300	30 pcs	800	1350	2450	238	2,50
44 60 63 042	750	350	450	30 pcs	800	1350	2450	238	2,50
44 60 63 030	800	500	475	28 pcs	1000	1350	2500	243	3,38
44 60 63 020	1000	500	480	24 pcs	1000	1400	2500	246	3,83

* Wooden pallet packaging

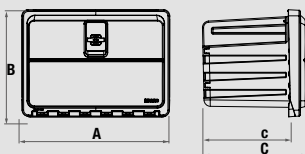

ORIGIN assembled version

Code	A	B	C	std packaging	W	T	H	gross weight (kg)*	volume (m ³)
44 60 64 116	400	350	375	40 pcs	800	1300	2100	145	2,76
44 60 64 100	500	350	455	40 pcs	1000	1350	2500	165	2,60
44 60 64 090	600	400	475	30 pcs	1000	1200	2400	184	3,17
44 60 64 045	690	500	480	20 pcs	1000	1350	2500	149	3,38
44 60 64 043	750	350	300	28 pcs	800	1350	2400	163	2,30
44 60 64 042	750	350	450	20 pcs	800	1350	2400	223	2,30
44 60 64 030	800	500	475	18 pcs	1000	1400	2500	161	3,50
44 60 64 020	1000	500	480	15 pcs	1000	1450	2550	159	3,57

ORIGIN dis-assembled version

Code	A	B	C	std packaging	W	T	H	gross weight (kg)*	volume (m ³)
44 60 69 116	400	350	375	50 pcs	800	1200	2200	178	2,35
44 60 69 100	500	350	455	64 pcs	1000	1350	2500	257	3,38
44 60 69 090	600	400	475	30 pcs	800	1200	2500	219	2,42
44 60 69 045	690	500	480	30 pcs	1000	1350	2500	217	2,97
44 60 69 043	750	350	300	30 pcs	800	1350	2450	238	2,30
44 60 69 042	750	350	450	30 pcs	800	1350	2450	238	2,30
44 60 69 030	800	500	475	24 pcs	1000	1350	2500	243	3,38
44 60 69 020	1000	500	480	20 pcs	1000	1500	2500	246	3,83

* Wooden pallet packaging

PACKAGING DETAILS TOOL BOXES

POLYBAG INDIVIDUAL PACKAGING - WOODEN PALLET

PLASTIC PALLET AVAILABILITY - PALLET FILM WRAP

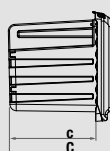
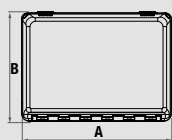
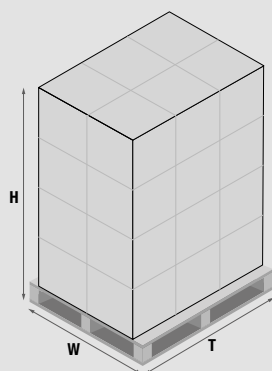

DAY TRIPPIN' assembled version

Code	A	B	C	std packaging	W	T	H	gross weight (kg)*	volume (m ³)
44 60 60 116	400	350	350	40 pcs	800	1300	2100	125	2,94
44 60 60 100	500	350	450	40 pcs	1000	1300	2550	149	2,60
44 60 60 090	600	400	470	30 pcs	1100	1200	2500	160	3,17
44 60 60 045	690	500	470	20 pcs	1000	1350	2500	131	3,38
44 60 60 030	800	500	470	18 pcs	1000	1400	2500	129	3,50
44 60 60 020	1000	500	470	15 pcs	1000	1400	2550	145	3,57

DAY TRIPPIN' dis-assembled version

Code	A	B	C	std packaging	W	T	H	gross weight (kg)*	volume (m ³)
44 60 61 116	400	350	350	64 pcs	800	1200	2100	193	2,35
44 60 61 100	500	350	450	64 pcs	1000	1350	2500	231	3,38
44 60 61 090	600	400	470	36 pcs	800	1200	2520	190	2,42
44 60 61 045	690	500	470	30 pcs	1000	1350	2500	190	2,97
44 60 61 030	800	500	470	28 pcs	1000	1350	2500	193	3,38
44 60 61 020	1000	500	470	24 pcs	1000	1500	2550	225	3,83

* Wooden pallet packaging

PACKAGING DETAILS WATER TANKS

CARDBOARD BOX INDIVIDUAL PACKAGING - WOODEN PALLET

PLASTIC PALLET AVAILABILITY - PALLET FILM WRAP

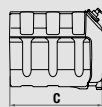
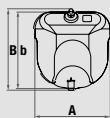
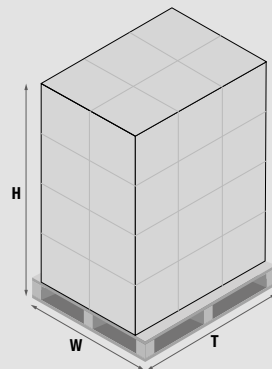

TANKY 30

Code	A	B	C	std packaging	W	T	H	gross weight (kg)*	volume (m ³)
52 55 15 010	350	380	430	60 pcs	1100	1400	2500	193	3,85
52 50 15 030	350	380	430	60 pcs	1100	1400	2500	193	3,85

TANKY 50

Code	A	B	C	std packaging	W	T	H	gross weight (kg)*	volume (m ³)
52 55 15 050	420	450	450	45 pcs	1350	1350	2500	247	4,55
52 50 15 050	420	450	450	45 pcs	1350	1350	2500	247	4,55

* Wooden pallet packaging – cardboard box individual packaging

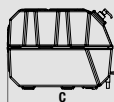
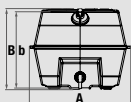

TANKYT00

Code	A	B	C	std packaging	W	T	H	gross weight (kg)*	volume (m ³)
52 50 32 010	382	283	400	42 pcs	850	1250	2400	131	2,55

* Wooden pallet packaging – cardboard box individual packaging

PACKAGING DETAILS MUDGUARDS & MUDFLAPS

CARDBOARD BOX - WOODEN PALLET -
PLASTIC PALLET AVAILABILITY - PALLET FILM WRAP

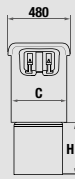
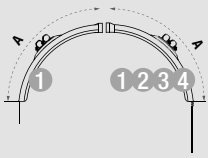
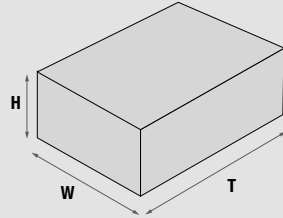

KOMPLEET KOMBI / KOMPLEET KOMBI TIPPER

	Code	A	C	H	std packaging 1 box	W	T	H	gross weight (kg)	volume (m ³)
①	15 60 45 010	945	450	-	18 pcs	800	1200	490	41	0,47
②	15 60 45 015	945	450	150	18 pcs	800	1200	490	45,5	0,47
③	15 60 45 020	945	450	250	18 pcs	800	1200	490	49	0,47
④	15 60 45 025	945	450	350	18 pcs	800	1200	490	53	0,47
⑤	15 60 46 001	900	450	300	18 pcs	800	1200	490	55	0,47

KOMPLEET

	Code	A	B	H	std packaging 1 box	W	T	H	gross weight (kg)	volume (m ³)
	15 60 01 008	700	450	-	48 pcs	800	1200	460	90	0,44
	15 60 10 170	700	450	160	42 pcs	800	1200	460	120	0,44
	15 60 11 170	700	450	250	30 pcs	800	1200	460	95	0,44
	15 60 12 170	700	450	350	30 pcs	800	1200	460	110	0,44

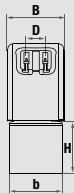
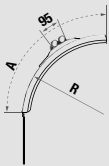

KOMPLEET KOMMA

	Code	A	B	H	std packaging 1 box	W	T	H	gross weight (kg)	volume (m ³)
	15 60 40 010	735	470	-	20 pcs	800	1200	480	41	0,46
	15 60 40 018	735	470	190	18 pcs	800	1200	480	45	0,46
	15 60 40 020	735	470	265	18 pcs	800	1200	480	47	0,46
	15 60 40 025	735	470	350	18 pcs	800	1200	480	48	0,46
	15 60 39 025	620	480	290	18 pcs	800	1200	480	55	0,46

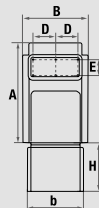

all dimensions are in mm

PACKAGING DETAILS MUDGUARDS

POLYBAG INDIVIDUAL PACKAGING - WOODEN PALLET -
PLASTIC PALLET AVAILABILITY - PALLET FILM WRAP

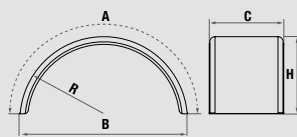
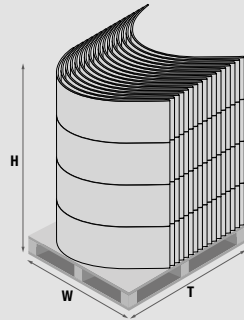

WHEELMATE Conventional mudguards

Code	A	B	C	std packaging	W	T	H	gross weight (kg)*	volume (m ³)
11 60 41 380	2100	1340	660	42 pcs	1300	1400	2200	270	4
11 60 41 410	2100	1350	440	60 pcs	1200	1350	2450	265	3,9
11 60 41 460	1940	1310	450	60 pcs	1200	1350	2450	223	3,9
11 60 41 505	1700	1100	560	50 pcs	1000	1350	2000	188	2,7
11 60 41 535	1600	1000	550	60 pcs	1000	1350	2000	193	2,7
11 60 41 540	1580	1000	500	80 pcs	1000	1350	2250	237	3,03
11 60 41 640	1400	900	450	80 pcs	950	1300	2000	197	2,47
11 60 41 643	1400	900	270	10 pcs	950	300	500	15	0,14
11 60 41 655	1380	890	400	100 pcs	950	1300	2200	213	2,72

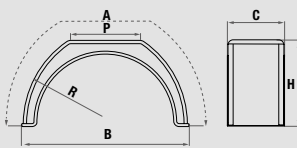

WHEELMATE Flat top mudguards

Code	A	B	C	std packaging	W	T	H	gross weight (kg)	volume (m ³)
11 60 42 610	1470	910	460	80 pcs	950	1300	2100	221	2,59
11 60 42 600	1500	900	310	90 pcs	950	1300	2200	229	2,93
11 60 42 509	1750	1000	510	80 pcs	950	1300	2100	245	2,59

* Wooden pallet packaging

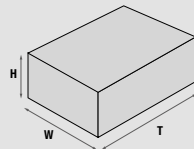

Cardboard box - Wooden pallet - Plastic pallet availability - Pallet film wrap



WHEELMATE Quarter mudguards

Code	A	B	C	std packaging 1 box	W	T	H	gross weight (kg)	volume (m ³)
11 60 40 080	1000	-	660	24 pcs	800	1200	670	77	0,64
11 60 40 095	1000	-	440	24 pcs	800	1200	450	53	0,43
11 60 40 130	800	-	670	50 pcs	800	1200	670	110	0,64
11 60 40 145	810	-	440	50 pcs	800	1200	450	80	0,43
11 60 40 155	700	-	670	50 pcs	800	1200	670	105	0,64
11 60 40 170	700	-	440	50 pcs	800	1200	450	75	0,43
11 60 01 010	640	-	720	50 pcs	800	1200	670	105	0,64

all dimensions are in mm

PACKAGING DETAILS MUDGUARDS & MUDFLAPS

POLYBAG INDIVIDUAL PACKAGING - WOODEN PALLET -
PLASTIC PALLET AVAILABILITY PALLET FILM WRAP

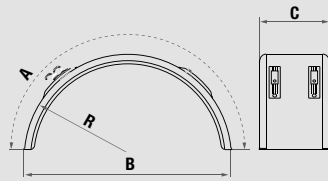
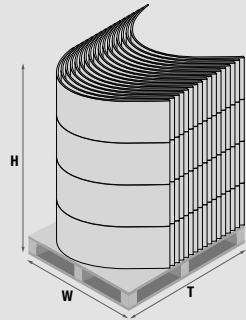

WHEELMATE PRO Conventional mudguards

Code	A	B	C	std packaging	W	T	H	gross weight (kg)	volume (m ³)
11 60 46 380	2100	1340	660	36 pcs	1400	1200	2300	287	3,86
11 60 46 410	2100	1350	440	48 pcs	1400	1200	2100	287	3,53
11 60 46 465	1900	1330	650	36 pcs	1350	1200	2300	276	3,73
11 60 46 460	1940	1310	450	48 pcs	1350	1200	2100	253	3,40
11 60 46 505	1700	1100	560	48 pcs	1000	1350	1900	253	2,72
11 60 46 535	1580	1000	550	48 pcs	1200	1000	1900	229	2,28
11 60 46 540	1580	1000	500	60 pcs	1200	1000	2200	271	2,64
11 60 46 640	1400	900	450	60 pcs	1200	900	2000	241	2,16
11 60 46 655	1380	890	400	72 pcs	1200	900	2200	265	2,38

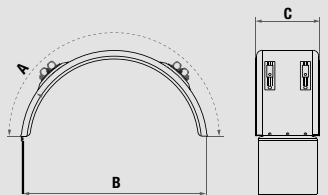

WHEELMATE PRO KOMPLEET Conventional mudguards

Code	A	B	C	std packaging	W	T	H	gross weight (kg)	volume (m ³)
14 60 35 380	2100	1340	660	24 pcs	1500	1200	2300	229	4,14
14 60 35 410	2100	1350	440	40 pcs	1500	1200	2400	265	4,32
14 60 35 465	1900	1330	650	24 pcs	1400	1200	2300	217	3,86
14 60 35 460	1940	1310	450	40 pcs	1400	1200	2400	249	4,03
14 60 35 505	1700	1100	560	36 pcs	1350	1200	1900	255	3,08

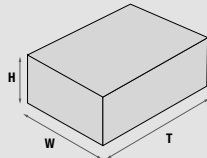

Cardboard box - Wooden pallet - Plastic pallet availability - Pallet film wrap



WHEELMATE PRO Quarter mudguards

Code	A	B	C	std packaging 1 box	W	T	H	gross weight (kg)	volume (m ³)
11 60 45 130	800	-	670	32 pcs	800	1200	670	68	0,64
11 60 45 145	810	-	440	32 pcs	800	1200	450	96	0,43
11 60 45 155	700	-	670	32 pcs	800	1200	670	112	0,64
11 60 45 170	700	-	440	32 pcs	800	1200	450	93	0,43
11 60 01 037	640	-	720	32 pcs	800	1200	670	112	0,64

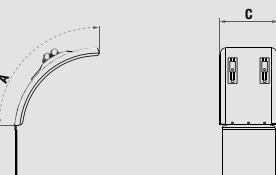

WHEELMATE PRO KOMPLEET Quarter mudguards

Code	A	B	C	std packaging 1 box	W	T	H	gross weight (kg)	volume (m ³)
14 60 30 130	800	-	670	18 pcs	800	1200	670	38	0,64
14 60 30 145	810	-	440	18 pcs	800	1200	450	54	0,43
14 60 30 155	700	-	670	18 pcs	800	1200	670	63	0,64
14 60 30 170	700	-	440	18 pcs	800	1200	450	53	0,43

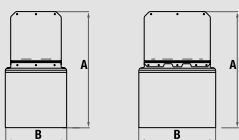

SPRAY BUSTER

Code	A	B	C	std packaging 1 box	W	T	H	gross weight (kg)	volume (m ³)
12 60 64 210	780	412		12 pcs	800	450	200	20,2	0,07
12 60 64 216	780	508		12 pcs	800	550	200	25	0,08
12 60 64 220	780	604		12 pcs	800	650	200	35	0,1

all dimensions are in mm

PACKAGING DETAILS FIRE EXTINGUISHER BOXES

POLYBAG INDIVIDUAL PACKAGING - WOODEN PALLET -
PLASTIC PALLET AVAILABILITY - PALLET FILM WRAP

CARDBOARD BOX INDIVIDUAL PACKAGING - WOODEN PALLET -
PLASTIC PALLET AVAILABILITY - PALLET FILM WRAP

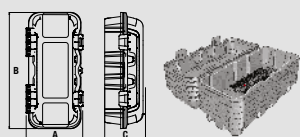
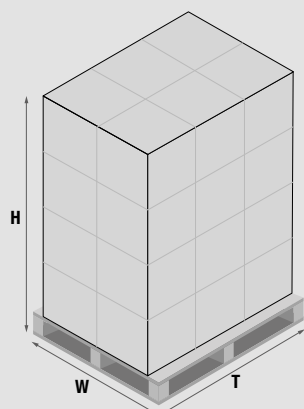

SHELLY

Code	extinguisher	A	B	C	std packaging	W	T	H	gross weight (kg)*	volume (m ³)
49 61 45 010	6 kg	305	627	220	18 pcs	404	1195	625	34	0,3
49 61 45 010	6 kg	305	627	220	126 pcs	800	1200	2300	252	2,21

* Wooden pallet packaging

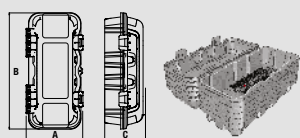

SHELLY SOLID RED

Code	extinguisher	A	B	C	std packaging	W	T	H	gross weight (kg)*	volume (m ³)
49 61 46 010	6 kg	305	627	220	18 pcs	404	1195	625	34	0,3
49 61 46 010	6 kg	305	627	220	126 pcs	800	1200	2300	252	2,21

* Wooden pallet packaging

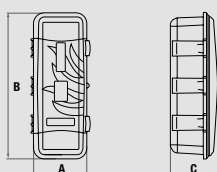

FITEASY

Code	extinguisher	A	B	C	std packaging	W	T	H	gross weight (kg)*	volume (m ³)
49 66 23 010	6kg	300	610	255	42 pcs	800	1250	2300	190	2,3
49 66 23 013	6/9kg	300	700	255	42 pcs	800	1400	2300	210	2,58
49 66 23 015	9/12kg	300	775	255	32 pcs	800	1250	2300	173	2,3

* Wooden pallet packaging

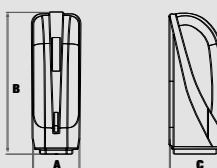

RELEASEY

Code	extinguisher	A	B	C	std packaging	W	T	H	gross weight (kg)*	volume (m ³)
49 56 18 010	6kg	260	635	275	48 pcs	900	1300	2500	198	2,93
49 56 18 015	9/12kg	255	765	300	28 pcs	800	1250	2200	159	2,2

49 50 18 010	6kg	260	635	275	48 pcs	900	1300	2500	198	2,93
49 50 18 015	9/12kg	255	765	300	28 pcs	800	1250	2200	159	2,2

* Wooden pallet packaging

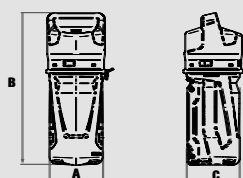

FOLPY

Code	extinguisher	A	B	C	std packaging	W	T	H	gross weight (kg)*	volume (m ³)
49 56 40 010	6kg	282	636	250	36 pcs	800	1200	2100	80	2,01

* Wooden pallet packaging

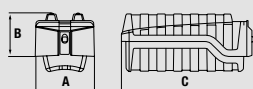

SLYKÒN

Code	extinguisher	A	B	C	std packaging	W	T	H	gross weight (kg)*	volume (m ³)
49 66 25 013	6/9/12 kg	320	311	729	42 pcs	1000	1600	2500	160	4

* Wooden pallet packaging

PACKAGING DETAILS WHEEL CHOCKS

POLYBAG INDIVIDUAL PACKAGING - WOODEN PALLET -
 PLASTIC PALLET AVAILABILITY - PALLET FILM WRAP

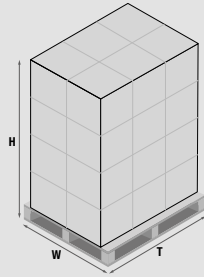

SOPÉO

Code	A	B	C	std packaging	W	T	H	gross weight (kg)	volume (m ³)
48 63 22 001	380	160	190	216 pcs	800	1200	2200	229	2,11
48 63 23 001	380	160	190	216 pcs	800	1200	2200	250	2,11
48 63 12 001	470	200	230	130 pcs	800	1200	2200	192	2,11
48 63 13 001	470	200	230	130 pcs	800	1200	2200	205	2,11

MINI SOPÉO 13-14

Code	A	B	C	std packaging	W	T	H	gross weight (kg)	volume (m ³)
31 60 29 100	380	160	190	60 pcs	600	400	500	17	0,12
31 60 29 100	380	160	190	1200 pcs	800	1200	2300	330	2,21

all dimensions are in mm

Concept: Grevi

Photo: Giancarlo Gennaro - The Studio

Copy: Silva Fedrigo

Print: Tipografia Sartore

May 2026

LAGO Accessori srl reserves
the right to make any change
or improvement to their
products and to this document
at any time and without any
prior notification



LAGO Accessori srl
Via 1° Maggio, 20
35014 Fontaniva (Padova) ITALY
Tel. +39 049 594 09 32
info@lagoaccessori.net
www.lagoaccessori.it



LAGOACCESSORI.IT